



see what Delta can do™

2013 Parts Catalog TUB SHOWER

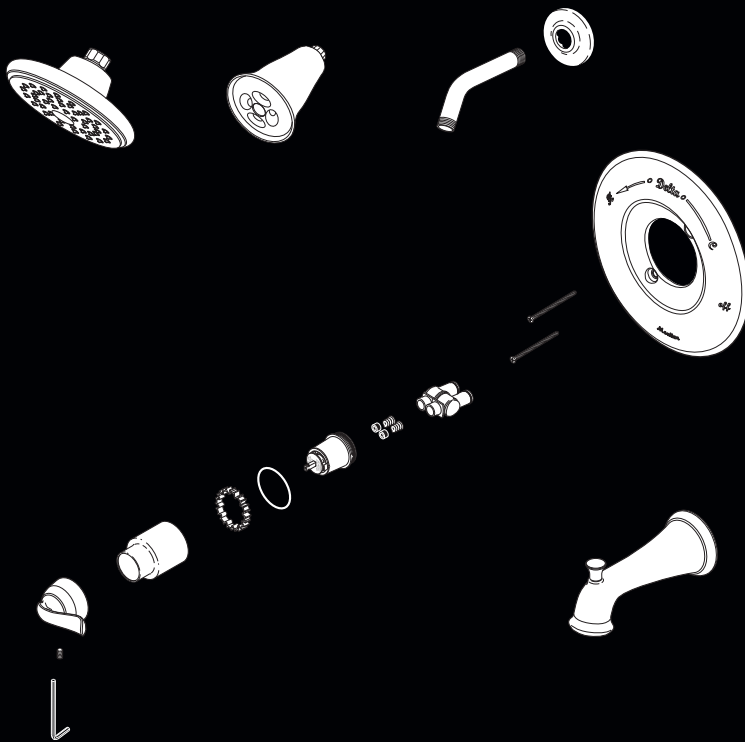

Table of Contents—By Series



Series Name	Model Number	Page Number
Delta® Cartridges	13/14, 17 & 17T	1
Addison®	T14092	2
Addison®	T14192	2
Addison®	T14292	2
Addison®	T14492	2
Addison®	T17092	3
Addison®	T17292	3
Addison®	T17492	3
Addison®	T17T092	4
Addison®	T17T292	4
Addison®	T17T492	4
Addison®	T2792	5
Addison®	T4792	5
Carlisle	142939-I	6
Carlisle	144939-I	6
Carlisle	172939	7
Carlisle	174939	7
Cassidy™	T14097-LHP	8
Cassidy™	T14297-LHP	8
Cassidy™	T14497-LHP	8
Cassidy™	T17097	9
Cassidy™	T17297	9
Cassidy™	T17497	9
Cassidy™	T17T097	10
Cassidy™	T17T297	10
Cassidy™	T17T497	10
Cassidy™	T2795-LHP	11
Cassidy™	T4795-LHP	11
Cassidy™	T2797-LHP	12
Cassidy™	T4797-LHP	12
Celice	142705	13
Celice	144705	13
Compel™	T14061	14
Compel™	T14261	14
Compel™	T14461	14
Compel™	T17061	15
Compel™	T17261	15
Compel™	T17461	15
Compel™	T2761	16
Compel™	T4761	16
C-Spout	T2783	37
Dryden™	T14051	17
Dryden™	T14251	17
Dryden™	T14451	17
Dryden™	T17051	18
Dryden™	T17251	18
Dryden™	T17251-H2O	18
Dryden™	T17451	18
Dryden™	T17451-H2O	18
Dryden™	T17T051	19
Dryden™	T17T251	19
Dryden™	T17T451	19
Dryden™	T2751	20
Dryden™	T4751	20
Ellington®	T14169	21
Ellington®	T14269	21
Ellington®	T14469	21
Foundations® Core-B	B112900	22
Foundations® Core-B	B114900	22
Foundations® Core-B	BT13010	23
Foundations® Core-B	BT13210	23
Foundations® Core-B	BT13410	23
Foundations® Core-B	BT14096	24
Foundations® Core-B	BT14296	24
Foundations® Core-B	BT14496	24
Foundations® Windemere	142996	25
Foundations® Windemere	144996	25
Foundations®	BT2710	26
Foundations®	BT2796	27
Grail®	T14085	28
Grail®	T14185	28

Series Name	Model Number	Page Number
Grail®	T14285	28
Grail®	T14285-H2O	28
Grail®	T14485	28
Grail®	T14485-H2O	28
Grail®	T17085	29
Grail®	T17285	29
Grail®	T17285-H2O	29
Grail®	T17485	29
Grail®	T17485-H2O	29
Grail®	T17T085	30
Grail®	T17T285	30
Grail®	T17T485	30
Grail®	T2785	31
Innovations®	T14030-LHP	32
Innovations®	T14130-LHP	32
Innovations®	T14230-LHP	32
Innovations®	T14430-LHP	32
Innovations®	T17030	33
Innovations®	T17230	33
Innovations®	T17230-H2O	33
Innovations®	T17430	33
Innovations®	T17430-H2O	33
Innovations®	T17T030	34
Innovations®	T17T230	34
Innovations®	T17T430	34
Innovations®	T18430	35
Innovations®	T18T230	36
Innovations®	T2730	37
Lahara®	T14038	38
Lahara®	T14238	38
Lahara®	T14238-H2O	38
Lahara®	T14438	38
Lahara®	T14438-H2O	38
Lahara®	144938-I	39
Lahara®	T17038	40
Lahara®	T17138	40
Lahara®	T17238	40
Lahara®	T17238-H2O	40
Lahara®	T17438	40
Lahara®	T17438-H2O	40
Lahara®	T17T038	41
Lahara®	T17T238	41
Lahara®	T17T438	41
Lahara®	T2738	42
Lahara®	T4738	42
Leland®	T14078	43
Leland®	T14178	43
Leland®	T14278	43
Leland®	T14278-H2O	44
Leland®	T14478	43
Leland®	T14478-H2O	44
Leland®	T17078	45
Leland®	T17178	45
Leland®	T17278	45
Leland®	T17278-H2O	45
Leland®	T17478	45
Leland®	T17478-H2O	45
Leland®	T17T078	46
Leland®	T17T278	46
Leland®	T17T478	46
Leland®	T2775	49
Leland®	T2778	47
Leland®	T4775	49
Leland®	T4778	48
Leland®	T5778	47
Linden™	T14094	50
Linden™	T14194	50
Linden™	T14294	50
Linden™	T14294-H2O	50
Linden™	T14494	50
Linden™	T14494-H2O	50

Series Name	Model Number	Page Number	Series Name	Model Number	Page Number
Linden™	T17094	51	Victorian®	T17T255	69
Linden™	T17294	51	Victorian®	T17T455	69
Linden™	T17294-I	51	Victorian®	T18255-XO	71
Linden™	T17494	51	Victorian®	T18455	70
Linden™	T17494-I	51	Victorian®	T2755	72
Linden™	T2794	52	Victorian®	T4755	73
Linden™	T4794	52	Victorian®	RP33791	74
Linden™	144962	53	1400 Series	T14088	75
Nura	142710	54	1400 Series	T14188	75
Nura	144710	54	1400 Series	T14288	75
Porter	144984	55	1400 Series	T14488	75
Porter	37984	56	1700 Series	T17088	76
Rizu®	T14082	28	1700 Series	T17288	76
Rizu®	T14282	28	1700 Series	T17488	76
Rizu®	T14482	28	Classic/Core	T13020	77
Rizu®	T17082	29	Classic/Core	T13020-DPE	77
Rizu®	T17282	29	Classic/Core	T13120	77
Rizu®	T17482	29	Classic/Core	T13122	77
Rizu®	T17T082	30	Classic/Core	T13220	77
Rizu®	T17T282	30	Classic/Core	T13220-DPE	77
Rizu®	T17T482	30	Classic/Core	T13220-H2O	77
Talbott	142960	57	Classic/Core	T13220-H2OT	77
Talbott	144960	57	Classic/Core	T13222	77
Trinsic™	T14059	58	Classic/Core	T13420	77
Trinsic™	T14259	58	Classic/Core	T13420-DPE	77
Trinsic™	T14459	58	Classic/Core	T13420-H2O	77
Trinsic™	T17059	59	Classic/Core	T13420-H2OT	77
Trinsic™	T17259	59	Classic/Core	T13422	77
Trinsic™	T17459	59	Classic/Core	T17030	78
Trinsic™	T2759	60	Classic/Core	T17130	78
Trinsic™	T4759	60	Classic/Core	T17230	78
Urban Arzo™	T14086	61	Classic/Core	T17230-H2O	78
Urban Arzo™	T14186	61	Classic/Core	T17430	78
Urban Arzo™	T14286	61	Classic/Core	T17430-H2O	78
Urban Arzo™	T14286-H2O	61	Classic/Core	T4705	79
Urban Arzo™	T14286-SHQ	61	Classic/Core	T5722	80
Urban Arzo™	T14486	61	Classic/Core	R10000—MultiChoice® Rough	81
Urban Arzo™	T14486-H2O	61	Classic/Core	T13090	82
Urban Arzo™	T14486-SHQ	61	Classic/Core	T13091	82
Urban Arzo™	T17086	62	Classic/Core	T13290	82
Urban Arzo™	T17286	62	Classic/Core	T13291	82
Urban Arzo™	T17486	62	Classic/Core	T13490	82
Vero™	T14053	63	Classic/Core	T13491	82
Vero™	T14253	63	Jetted Shower	R1817	83
Vero™	T14253-H2O	63	Jetted Shower	R1827	83
Vero™	T14453	63	Jetted Shower	T1817	83
Vero™	T14453-H2O	63	Jetted Shower	T1837	83
Vero™	T17053	64	Jetted Shower	T18017	83
Vero™	T17153	64	Jetted Shower	T18037	83
Vero™	T17253	64	Classic/Core	R2707	84
Vero™	T17253-H2O	64	Classic/Core	T2705	85
Vero™	T17453	64	Classic/Core	RP14979	86
Vero™	T17453-H2O	64	Body Spray	50000	87
Vero™	T17T053	65	Handshowers	54510	88
Vero™	T17T253	65	Handshowers	54513	88
Vero™	T17T453	65	Handshowers	56510	88
Vero™	T2753	66	Handshowers	56513	88
Vero™	T4753	66	Handshowers	54713	88
Victorian®	T14055-LHP	67	Handshowers	55710	88
Victorian®	T14155-LHP	67	Handshowers	56713	88
Victorian®	T14255-LHP	67	Handshowers	54613	88
Victorian®	T14255-LHP-H2O	67	Handshowers	56613	88
Victorian®	T14455-LHP	67	Bath Waste	RP293	90
Victorian®	T14455-LHP-H2O	67	Bath Waste	RP693	90
Victorian®	T17055	68	Bath Waste	RP393	91
Victorian®	T17155	68	Bidet	33 Series	92
Victorian®	T17255	68	Bidet	44 Series	93
Victorian®	T17255-H2O	68	Bidet Handles	33, 44 Series	94
Victorian®	T17455	68			
Victorian®	T17455-H2O	68			
Victorian®	T17T055	69			

Table of Contents—By Model Number



Series Name	Model Number	Page Number
13/14, 17 & 17T	Delta® Cartridges	1
33 Series	Bidet	92
33 Series	Bidet Handles	94
44 Series	Bidet	93
44 Series	Bidet Handles	94
37984	Porter	56
50000	Body Spray	87
54510	Handshowers	88
54513	Handshowers	88
54613	Handshowers	88
54713	Handshowers	88
55710	Handshowers	88
56510	Handshowers	88
56513	Handshowers	88
56613	Handshowers	88
56713	Handshowers	88
142705	Celice	13
142710	Nura	54
142939-I	Carlisle	6
142960	Talbott	57
142996	Foundations® Windemere	25
144705	Celice	13
144710	Nura	54
144938-I	Lahara®	39
144939-I	Carlisle	6
144960	Talbott	57
144962	Linden™	53
144996	Foundations® Windemere	25
144984	Porter	55
172939	Carlisle	7
174939	Carlisle	7
B112900	Foundations® Core-B	22
B114900	Foundations® Core-B	22
BT13010	Foundations® Core-B	23
BT13210	Foundations® Core-B	23
BT13410	Foundations® Core-B	23
BT14096	Foundations® Core-B	24
BT14296	Foundations® Core-B	24
BT14496	Foundations® Core-B	24
BT2710	Foundations®	26
BT2796	Foundations®	27
R1817	Jetted Shower	83
R1827	Jetted Shower	83
R2707	Classic/Core	84
R10000—Rough Valve	Classic/Core	81
RP293	Bath Waste	90
RP393	Bath Waste	91
RP693	Bath Waste	90
RP14979	Classic/Core	86
RP33791	Victorian®	74
T1817	Jetted Shower	83
T1837	Jetted Shower	83
T2705	Classic/Core	85
T2730	Innovations®	37
T2738	Lahara®	42
T2751	Dryden™	20
T2753	Vero™	66
T2755	Victorian®	72
T2759	Trinsic™	60
T2761	Compel™	16
T2775	Leland®	49
T2778	Leland®	47
T2783	C-Spout	37
T2785	Grail®	31
T2792	Addison®	5
T2794	Linden™	52
T2795-LHP	Cassidy™	11
T2797-LHP	Cassidy™	12
T4705	Classic/Core	79
T4738	Lahara®	42
T4751	Dryden™	20

Series Name	Model Number	Page Number
T4753	Vero™	66
T4755	Victorian®	73
T4759	Trinsic™	60
T4761	Compel™	16
T4775	Leland®	49
T4778	Leland®	48
T4792	Addison®	5
T4794	Linden™	52
T4795-LHP	Cassidy™	11
T4797-LHP	Cassidy™	12
T5722	Classic/Core	80
T5778	Leland®	47
T13020	Classic/Core	77
T13020-DPE	Classic/Core	77
T13090	Classic/Core	82
T13091	Classic/Core	82
T13120	Classic/Core	77
T13122	Classic/Core	77
T13220	Classic/Core	77
T13220-DPE	Classic/Core	77
T13220-H2O	Classic/Core	77
T13220-H2OT	Classic/Core	77
T13222	Classic/Core	77
T13290	Classic/Core	82
T13291	Classic/Core	82
T13420	Classic/Core	77
T13420-DPE	Classic/Core	77
T13420-H2O	Classic/Core	77
T13420-H2OT	Classic/Core	77
T13422	Classic/Core	77
T13490	Classic/Core	82
T13491	Classic/Core	82
T14030-LHP	Innovations®	32
T14038	Lahara®	38
T14051	Dryden™	17
T14053	Vero™	63
T14055-LHP	Victorian®	67
T14059	Trinsic™	58
T14061	Compel™	14
T14078	Leland®	43
T14082	Rizu®	28
T14085	Grail®	28
T14086	Urban Arzo™	61
T14088	1400 Series	75
T14092	Addison®	2
T14094	Linden™	50
T14097-LHP	Cassidy™	8
T14130-LHP	Innovations®	32
T14155-LHP	Victorian®	67
T14169	Ellington®	21
T14178	Leland®	43
T14185	Grail®	28
T14186	Urban Arzo™	61
T14188	1400 Series	75
T14192	Addison®	2
T14194	Linden™	50
T14230-LHP	Innovations®	32
T14238	Lahara®	38
T14238-H2O	Lahara®	38
T14251	Dryden™	17
T14253	Vero™	63
T14253-H2O	Vero™	63
T14255-LHP	Victorian®	67
T14255-LHP-H2O	Victorian®	67
T14259	Trinsic™	58
T14261	Compel™	14
T14269	Ellington®	21
T14278	Leland®	43
T14278-H2O	Leland®	44
T14282	Rizu®	28
T14285	Grail®	28

Series Name	Model Number	Page Number
T14285-H2O	Grail®	28
T14286	Urban Arzo™	61
T14286-H2O	Urban Arzo™	61
T14286-SHQ	Urban Arzo™	61
T14288	1400 Series	75
T14292	Addison®	2
T14294	Linden™	50
T14294-H2O	Linden™	50
T14297-LHP	Cassidy™	8
T14430-LHP	Innovations®	32
T14438	Lahara®	38
T14438-H2O	Lahara®	38
T14451	Dryden™	17
T14453	Vero™	63
T14453-H2O	Vero™	63
T14455-LHP	Victorian®	67
T14455-LHP-H2O	Victorian®	67
T14459	Trinsic™	58
T14461	Compel™	14
T14469	Ellington®	21
T14478	Leland®	43
T14478-H2O	Leland®	44
T14482	Rizu®	28
T14485	Grail®	28
T14485-H2O	Grail®	28
T14486	Urban Arzo™	61
T14486-H2O	Urban Arzo™	61
T14486-SHQ	Urban Arzo™	61
T14488	1400 Series	75
T14492	Addison®	2
T14494	Linden™	50
T14494-H2O	Linden™	50
T14497-LHP	Cassidy™	8
T17030	Classic/Core	78
T17030	Innovations®	33
T17038	Lahara®	40
T17051	Dryden™	18
T17053	Vero™	64
T17055	Victorian®	68
T17059	Trinsic™	59
T17061	Compel™	15
T17078	Leland®	45
T17082	Rizu®	29
T17085	Grail®	29
T17086	Urban Arzo™	62
T17088	1700 Series	76
T17092	Addison®	3
T17094	Linden™	51
T17097	Cassidy™	9
T17130	Classic/Core	78
T17138	Lahara®	40
T17153	Vero™	64
T17155	Victorian®	68
T17178	Leland®	45
T17230	Classic/Core	78
T17230-H2O	Classic/Core	78
T17230	Innovations®	33
T17230-H2O	Innovations®	33
T17238	Lahara®	40
T17238-H2O	Lahara®	40
T17251	Dryden™	18
T17251-H2O	Dryden™	18
T17253	Vero™	64
T17253-H2O	Vero™	64
T17255	Victorian®	68
T17255-H2O	Victorian®	68
T17259	Trinsic™	59
T17261	Compel™	15
T17278	Leland®	45
T17278-H2O	Leland®	45
T17282	Rizu®	29

Series Name	Model Number	Page Number
T17285	Grail®	29
T17285-H2O	Grail®	29
T17286	Urban Arzo™	62
1700 Series	T17288	76
T17292	Addison®	3
T17294	Linden™	51
T17294-l	Linden™	51
T17297	Cassidy™	9
T17430	Classic/Core	78
T17430-H2O	Classic/Core	78
T17430	Innovations®	33
T17430-H2O	Innovations®	33
T17438	Lahara®	40
T17438-H2O	Lahara®	40
T17451	Dryden™	18
T17451-H2O	Dryden™	18
T17453	Vero™	64
T17453-H2O	Vero™	64
T17455	Victorian®	68
T17455-H2O	Victorian®	68
T17459	Trinsic™	59
T17461	Compel™	15
T17478	Leland®	45
T17478-H2O	Leland®	45
T17482	Rizu®	29
T17485	Grail®	29
T17485-H2O	Grail®	29
T17486	Urban Arzo™	62
T17488	1700 Series	76
T17492	Addison®	3
T17494	Linden™	51
T17494-l	Linden™	51
T17497	Cassidy™	9
T17T030	Innovations®	34
T17T038	Lahara®	41
T17T051	Dryden™	19
T17T053	Vero™	65
T17T055	Victorian®	69
T17T078	Leland®	46
T17T082	Rizu®	30
T17T085	Grail®	30
T17T092	Addison®	4
T17T097	Cassidy™	10
T17T230	Innovations®	34
T17T238	Lahara®	41
T17T251	Dryden™	19
T17T253	Vero™	65
T17T255	Victorian®	69
T17T278	Leland®	46
T17T282	Rizu®	30
T17T285	Grail®	30
T17T292	Addison®	4
T17T297	Cassidy™	10
T17T430	Innovations®	34
T17T438	Lahara®	41
T17T451	Dryden™	19
T17T453	Vero™	65
T17T455	Victorian®	69
T17T478	Leland®	46
T17T482	Rizu®	30
T17T485	Grail®	30
T17T492	Addison®	4
T17T497	Cassidy™	10
T18017	Jetted Shower	83
T18037	Jetted Shower	83
T18255-XO	Victorian®	71
T18430	Innovations®	35
T18455	Victorian®	70
T18T230	Innovations®	36

Delta Pressure Balanced and Thermostatic Valve Cartridges

Cartridge Summary Reference Sheet		
Units shipped in March 2006 and after.	Units shipped before March 2006.	Replacement cartridges shipped in July 2006 and after.
<p>MultiChoice® 13/14</p> <p>Longer Lower Housing Grey Off White</p> <p>Order RP46074 to Replace Cartridge.</p>	<p>Old Monitor® 1300/1400</p> <p>Shorter Lower Housing White Blue or Off White</p> <p>Order RP19804 to Replace Cartridge.</p>	<p>New Monitor® 1300/1400</p> <p>Shorter Lower Housing White Blue</p> <p>Order RP19804 to Replace Cartridge.</p>
<p>17</p> <p>Grey Upper Cap V Notch Adapter Shorter Tab</p> <p>Order RP46463 to Replace Cartridge.</p>	<p>1700</p> <p>White Upper Cap Square Notch Longer Tab</p> <p>Order RP32104 to Replace Cartridge.</p>	<p>NA</p>
<p>17T</p> <p>Brass Black</p> <p>Order RP47201 to Replace Cartridge.</p>	<p>NA Will Not Fit</p>	<p>NA</p>

Addison™ Tub/Shower Trim Garniture pour Bain/Douche Addison™

Adorno Addison™ para Bañera/Ducha

Addison™ Tub/Shower

Models/Modelos/Modèles T14092, T14192, T14292 & T14492 Series/Series/Seria

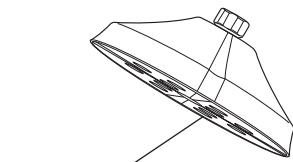

RP61265▲
Showerhead
Cabeza de Rogadora
Pomme de Douche

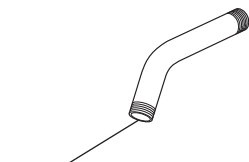

RP6023▲
Shower Arm
Brazo de la Rogadora
Tuyau de Pomme de Douche



RP61266▲
Shower Flange
Pestaña de la Rogadora
Collerette

RP196▲
Trim Screws/Atornillos de Franja/Vis de Finition

RP12630▲
For Longer Screws
Para Tornillos Más Grandes
Pour Vis Plus Longues

***RP46074**
Valve Cartridge
Válvula de Cartucho
Cartouche

RP14414
O-Rings
Anillos "O"
Joints Toriques

RP23336
O-Ring
Anillo "O"
Joint Torique

RP29569
Spacer
Separadores
Pièce D'espacement

RP4993
Seats & Springs
Asientos y Resortes
Sièges et Ressorts

RP50879▲
Trim Sleeve
Manga de Franja
Manchon de Finition

RP25620
Set Screw
Tornillo de Ajuste
Vis de Calage

RP61268▲
Handle Assembly
Ensamble de la Manija
Poignée

RP26853
Wrench
Llave
Clée

RP61267▲
Escutcheon
Roseta
Rosace avec Orifice

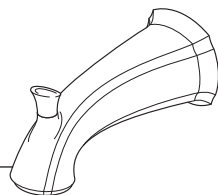

RP61269▲
Tub Spout/Pull-Up Diverter
Tubo de Salida para Bañera/
Botón Desviador de Alzar

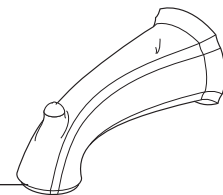

RP54863▲
Tub Spout/Non Diverter
Tubo de Salida para Bañera/Sin Desviador
Bec/Sans Dérivation

Bec/avec dérivation à tirette

Tub/Shower Trim Garniture pour Bain/Douche

Adorno para Bañera/Ducha

Models/Modelos/Modèles T17092, T17292 & T17492 Series/Series/Seria

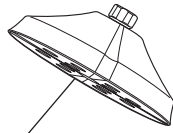

RP61265▲
Showerhead
Cabeza de Rogadora
Pomme de Douche



RP6023▲
Shower Arm
Brazo de la Rogadora
Tuyau de Pomme de Douche



RP61266▲
Shower Flange
Pestaña de la Rogadora
Collerette

RP32105
Screw/Tornillo/Vis

NOTE: Do NOT overtighten screw
NOTA: NO apriete demasiado el tornillo
NOTE: NE serrez PAS trop la vis

RP28598
Decal (Red/Blue)
Etiqueta (Rojo/Azul)
Etiquette (Rouge/Bleu)

RP50880▲
Trim Sleeve
Manga de Franja
Manchon de Finition

RP32102
Rotational Limit Stop
Tope para Limitar
Butée Rotative

RP61271▲
Handle Assembly
Ensamble de la Manija
Poignée

RP61272▲
Temperature Knob and Cover
Perilla de la Temperatura y Cubierta
Poignée de Réglage de Température

RP196▲
Trim Screws
Atornillos de Franja
Vis de Finition
RP12630▲
For Longer Screws
Para Tornillos Más Grandes
Pour Vis Plus Longues

***RP46463**
Cartridge Assembly
Cartucho
Cartouche

RP61270▲
Escutcheon
Roseta
Rosace avec Orifice

RP23336
O-Ring
Anillo "O"
Joint Torique

RP54863▲
Tub Spout/Non Diverter
Tubo de Salida para Bañera/
Sin Desviador
Bec/Sans Dérivation

RP61269▲
Tub Spout/Pull-Up Diverter
Tubo de Salida para Bañera/
Botón Desviador de Alzar
Bec/avec dérivation à tirette

Tub/Shower Trim Garniture pour Bain/Douche

Adorno para Bañera/Ducha

Models/Modelos/Modèles T17T092, T17T292 & T17T492 Series/Series/Seria

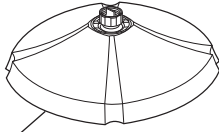

RP61274▲
Showerhead
Cabeza de Regadera
Pomme de Douche



RP61273▲
Shower Arm
Brazo de Regadera
Tuyau de Pomme de Douche



RP61266▲
Shower Flange
Pestaña de la Regadera
Collerette

RP61270▲
Escutcheon
(Diagonal Screw Holes)
Chapetón
(Huecos para los Tornillos Diagonales)
Rosace
(Trous de Vis en Diagonale)

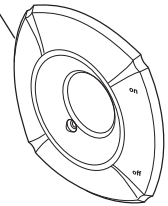

RP50879▲
Trim Sleeve
Manga de Franja
Manchon de Finition



RP61275▲
Handle Assembly
Ensamble de la Manija
Poignée



RP50465
Set Screw & Wrench
Tornillo de Ajuste y Llave
Vis de calage et Clé

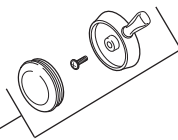

RP61276▲
Temperature Knob, Cover & Screw
Perilla de la Temperatura, Cubierta y Tornillo
Poignée de Réglage de Température et Vis

RP47201*
Cartridge Assembly
Cartucho
Cartouche



RP23336
O-Ring
Anillo "O"
Joint Torique

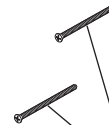

RP196▲
Trim Screws
Atornillos de Franja
Vis de Finition

RP12630▲
For Longer Screws
Para Tornillos Más Grandes
Pour Vis Plus Longues

RP54863▲
Tub Spout/Non Diverter
Tubo de Salida para Bañera/
Sin Desviador
Bec/Sans Dérivation

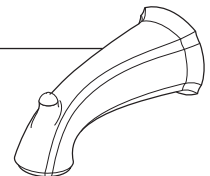

RP61269▲
Tub Spout/Pull-Up Diverter
Tubo de Salida para Bañera/
Botón Desviador de Alzar
Bec/avec dérivation à tirette

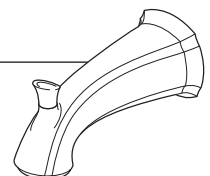

Addison™ Roman Tub Trim Garniture de Bain Romain Addison™

Adorno Addison™ para Bañera Romana

Addison™ Roman Tub

Models/Modelos/Modèles T2792 & T4792 Series/Series/Seria

T2792

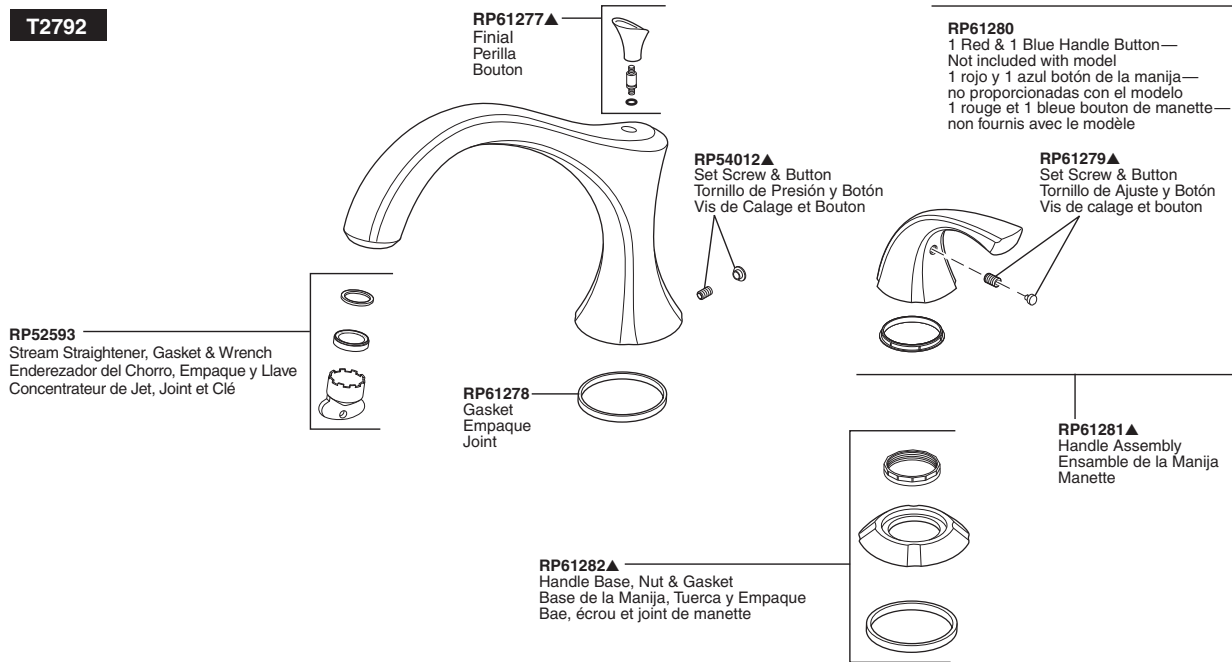

T4792

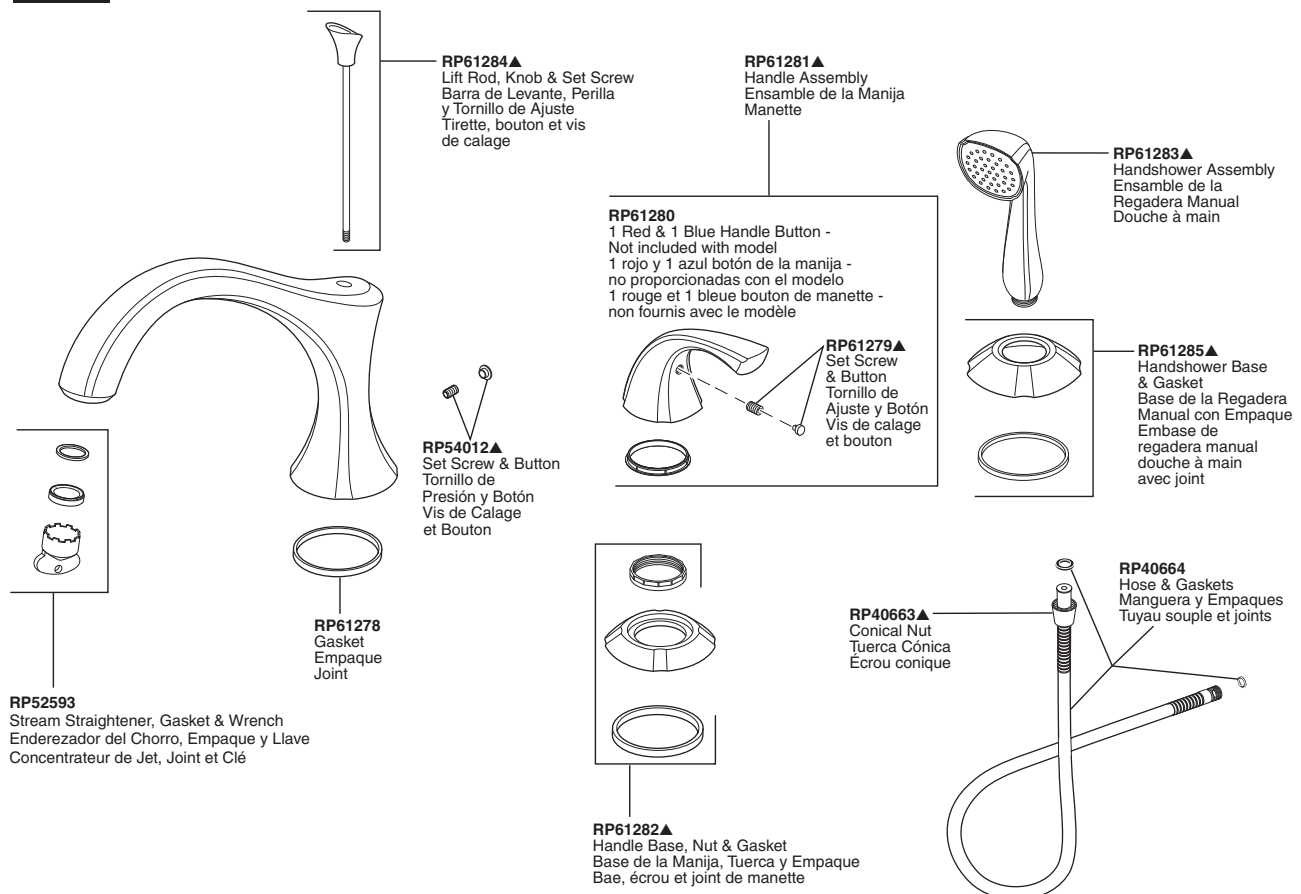

Carlisle Tub Shower Valve with In2ition® Showerhead Les Valves de Douche de Cuve de Carlisle avec In2ition®

Válvulas de Ducha de Tina de Carlisle con Regadera de In2ition®

Models/Modelos/Modèles 142939-I & 144939-I Series/Series/Seria

Carlisle Tub & Shower

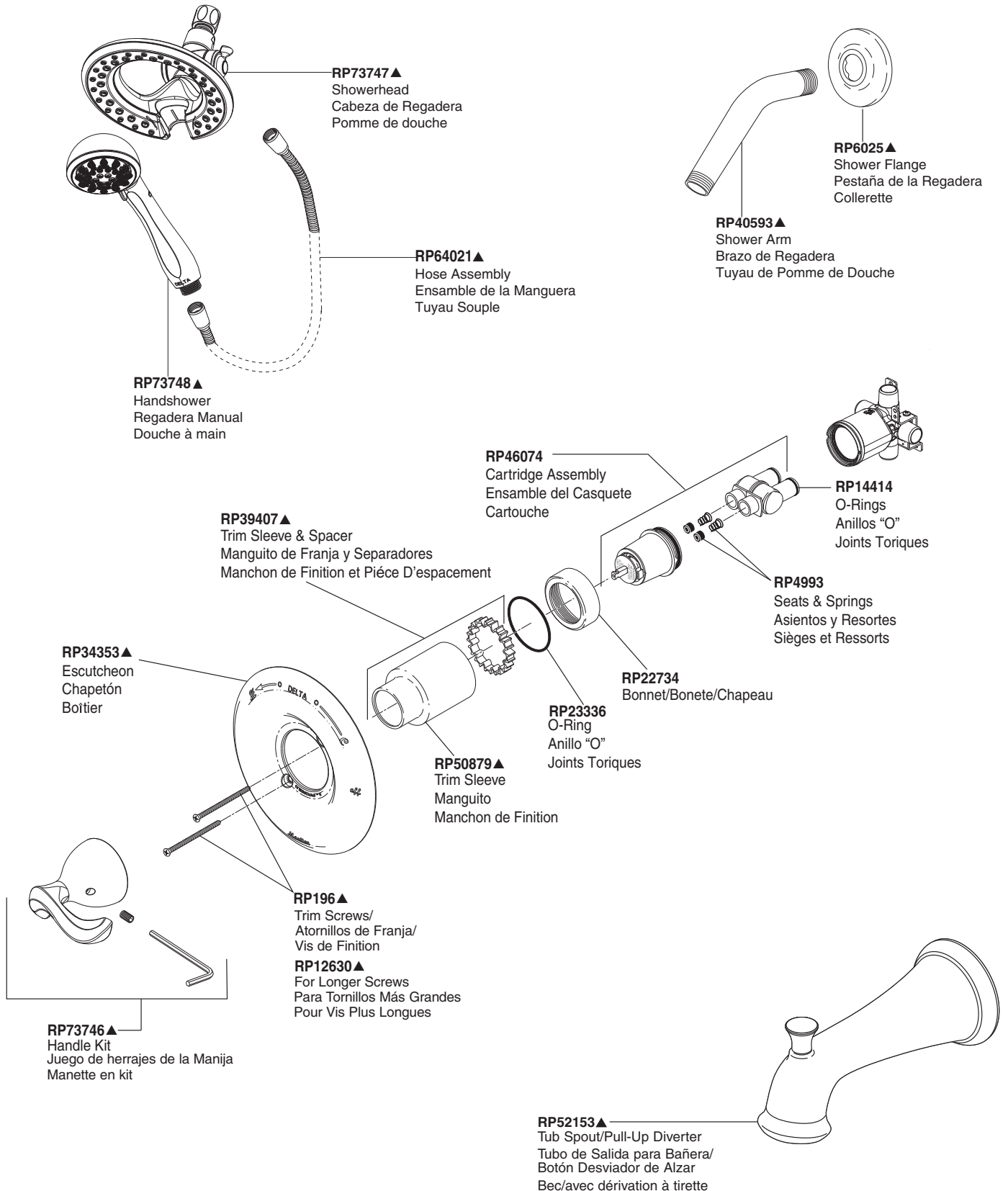

Carlisle Tub Shower Valve with In2ition® Showerhead Les Valves de Douche de Cuve de Carlisle avec In2ition®

Válvulas de Ducha de Tina de Carlisle con Regadera de In2ition®

Models/Modelos/Modèles 172939 & 174939 Series/Series/Seria

Carlisle Tub/Shower

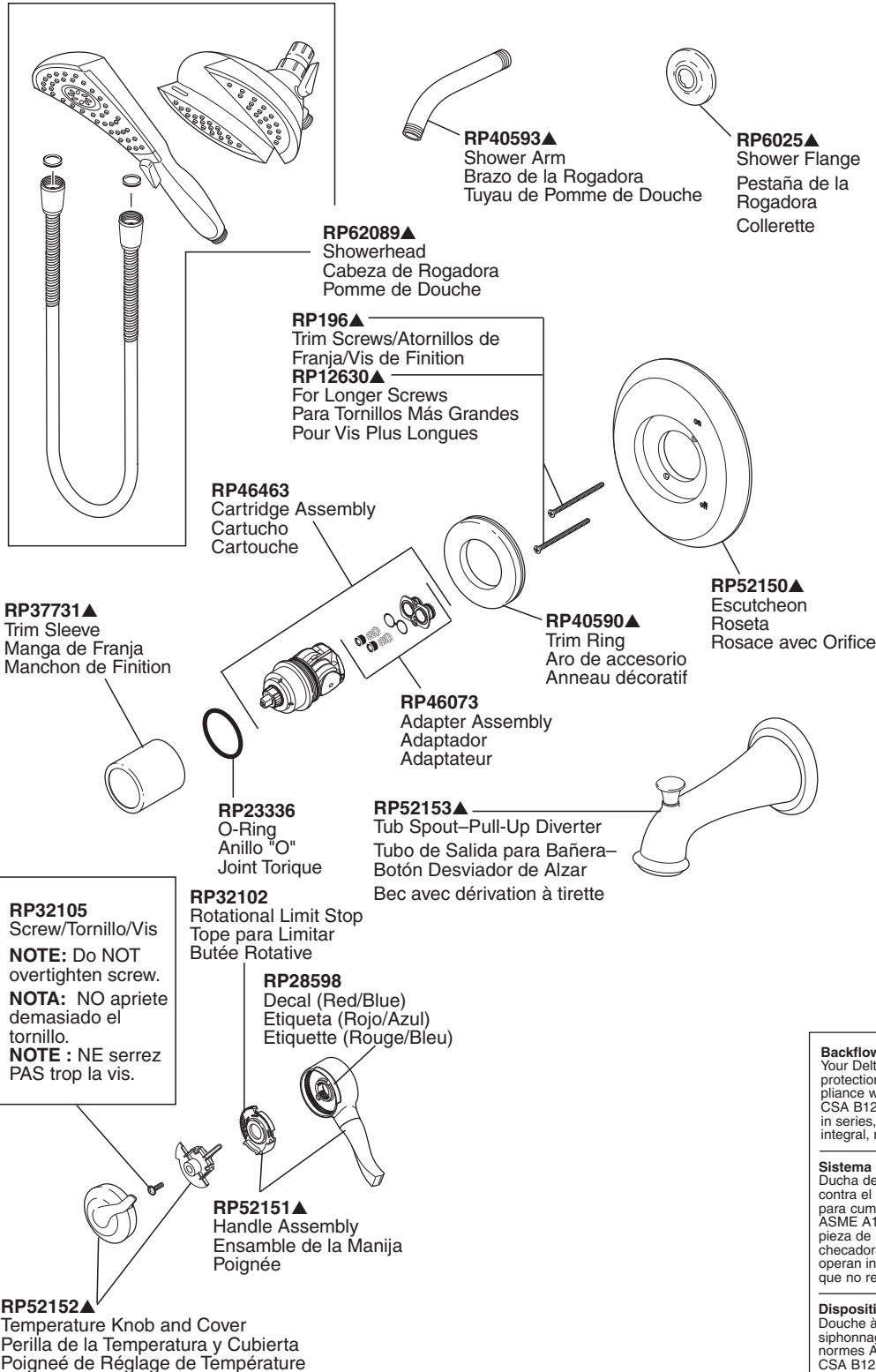

Backflow Protection System
Your Delta® hand shower incorporates a backflow protection system that has been tested to be in compliance with ASME A112.18.3 and ASME A112.18.1 / CSA B125.1. It incorporates two certified check valves in series, which operate independently and are integral, non-serviceable parts of the wand assembly.

Sistema de protección contra el contraflujo
Ducha de mano Delta® tiene un sistema de protección contra el contraflujo, incorporado, que ha sido probado para cumplir con los requisitos de ASME A112.18.3 y ASME A112.18.1 / CSA B125.1. Este incorpora en la pieza de mano dos válvulas de retención o checkadoras certificadas en una serie, las cuales operan independientemente y son piezas integrantes que no requieren servicio.

Dispositif anti-siphonnage
Douche à main Delta® comporte un dispositif anti-siphonnage qui a été éprouvé et qui est conforme aux normes ASME A112.18.3 et ASME A112.18.1 / CSA B125.1. Ce dispositif se compose de deux clapets indépendants homologués, montés en série dans le tube rigide, qui sont non réparables.

Cassidy Tub/Shower Trim Garniture pour Bain/Douche Cassidy

Adorno Cassidy para Bañera/Ducha

Cassidy™ Tub/Shower

Models/Modelos/Modèles T14097-LHP, T14297-LHP & T14497-LHP Series/Series/Seria

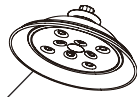

RP70172▲
Showerhead
Cabeza de Rogadora
Pomme de Douche



RP40593▲
Shower Arm
Brazo de la Rogadora
Tuyau de Pomme de Douche



RP72562▲
Shower Flange
Pestaña de la Rogadora
Collerette

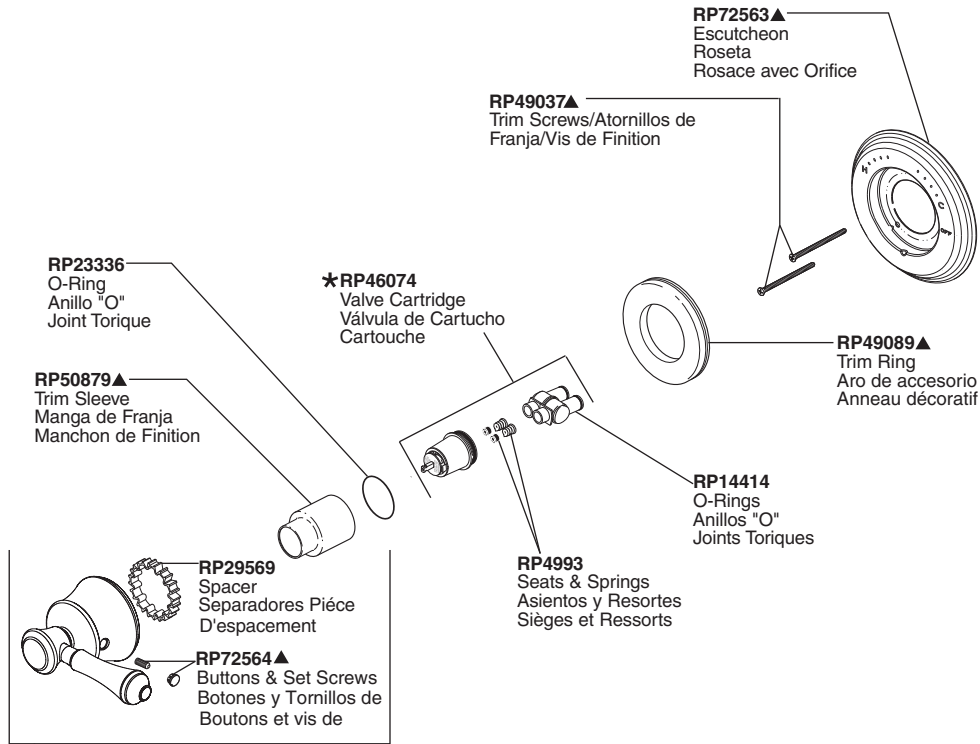

RP72563▲
Escutcheon
Roseta
Rosace avec Orifice

RP49037▲
Trim Screws/Atornillos de Franja/Vis de Finition

RP23336
O-Ring
Anillo "O"
Joint Torique

★RP46074
Valve Cartridge
Válvula de Cartucho
Cartouche

RP50879▲
Trim Sleeve
Manga de Franja
Manchon de Finition

RP49089▲
Trim Ring
Aro de accesorio
Anneau décoratif

RP29569
Spacer
Separadores Pièce
D'espacement

RP72564▲
Buttons & Set Screws
Botones y Tornillos de
Boutons et vis de

RP14414
O-Rings
Anillos "O"
Joints Toriques

RP4993
Seats & Springs
Asientos y Resortes
Sièges et Ressorts

H797▲
Handle Kit
Juego de herrajes de la Manija
Manette en kit

RP72566▲
Finial
Pomo
Grain

RP72564▲
Buttons & Set Screws
Botones y Tornillos de
Boutons et vis de

RP29569
Spacer
Separadores Pièce
D'espacement

H795▲
Handle Kit
Juego de herrajes
de la Manija
Manette en kit

H798▲
Handle Kit
Juego de herrajes de
la Manija
Manette en kit

RP29569
Spacer
Separadores Pièce
D'espacement

RP72564▲
Buttons & Set Screws
Botones y Tornillos de
Boutons et vis de

RP72565▲
Tub Spout/Pull-Up Diverter
Tubo de Salida para Bañera/
Botón Desviador de Alzar
Bec/avec dérivation à tirette

Cassidy Tub/Shower Trim Garniture pour Bain/Douche Cassidy

Adorno Cassidy para Bañera/Ducha

Models/Modelos/Modèles T17097, T17297 & T17497 Series/Series/Seria



RP70172▲
Showerhead
Cabeza de Rogadora
Pomme de Douche



RP40593▲
Shower Arm
Brazo de la Rogadora
Tuyau de Pomme de Douche



RP72562▲
Shower Flange
Pestaña de la Rogadora
Collerette

RP32105
Screw/Tornillo/Vis
NOTE: Do NOT overtighten screw.
NOTA: NO apriete demasiado el tornillo.
NOTE : NE serrez PAS trop la vis.

RP32102
Rotational Limit Stop
Tope para Limitar
Butée Rotative

RP50880▲
Trim Sleeve
Manga de Franja
Manchon de Finition

RP49037
Trim Screws
Atornillos de Franja
Vis de Finition

★ **RP46463**
Cartridge Assembly
Cartucho
Cartouche

RP72569▲
Escutcheon
Roseta
Rosace avec Orifice

RP49089▲
Trim Ring
Aro de accesorio
Anneau décoratif

RP23336
O-Ring
Anillo "O"
Joint Torique

RP72567▲
Handle Assembly
Ensamble de la Manija
Poignée

RP72572▲
Temperature Knob and Cover
Perilla de la Temperatura y Cubierta
Poignée de Réglage de Température

RP72566▲
Finial/Pomo/Grain

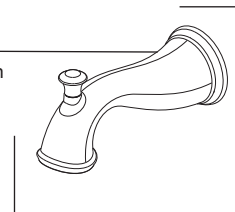

RP72565▲
Tub Spout/Pull-Up Diverter
Tubo de Salida para Bañera/
Botón Desviador de Alzar
Bec/avec dérivation à tirette

Tub/Shower Trim Garniture pour Bain/Douche

Adorno para Bañera/Ducha

Cassidy™ Tub/Shower

Models/Modelos/Modèles T17T097, T17T297 & T17T497 Series/Series/Seria



RP72568▲
Showerhead
Cabeza de Regadera
Pomme de Douche



RP61273▲
Shower Arm
Brazo de Regadera
Tuyau de Pomme de Douche



RP72562▲
Shower Flange
Pestaña de la Regadera
Collerette

RP72570▲
Handle Assembly
Ensamble de la Manija
Poignée

RP50879▲
Trim Sleeve
Manga de Franja
Manchon de Finition

RP52384
Buttons, Set Screws & Wrench
Botones, Tornillos de y Llave
Boutons, vis de et Clé

RP72571▲
Temperature Knob, Cover & Screw
Perilla de la Temperatura, Cubierta y Tornillo
Poigné de Réglage de Température et Vis

★ RP47201
Cartridge Assembly
Cartucho
Cartouche

RP49089▲
Trim Ring
Aro de accesorio
Anneau décoratif

RP49037
Trim Screws
Atornillos de Franja
Vis de Finition

RP23336
O-Ring
Anillo "O"
Joint Torique

RP72569▲
Escutcheon
(Diag. Screw Holes)
Chapetón
(Huecos para los
Tornillos Diagonales)
Rosace
(Trous de Vis
en Diagonale)

RP72566▲
Finial
Pomo
Grain

RP72565▲
Tub Spout/Pull-Up Diverter
Tubo de Salida para Bañera/
Botón Desviador de Alzar
Bec/avec dérivation à tirette

Cassidy™ Roman Tub Trim Garniture de Bain Romain Cassidy™

Adorno Cassidy™ para Bañera Romana

Cassidy™ Roman Tub

Models/Modelos/Modèles T2795 & T4795 Series/Series/Seria

Model / Modelo / Modèle T2795

RP72724▲
Finial/Pomo/Grain

RP73284▲
Set Screw & Button
Tornillo de Presión y Botón
Vis de Calage et Bouton

RP72718▲
Spout Base w/Gasket
Base del Tubo de Salida
con Empaque
Embase du Bec avec Joint

RP52593
Stream Straightener,
Gasket & Wrench
Enderezador del Chorro,
Empaque y Llave
Concentrateur de Jet, Joint et Clé

RP72722▲
Handle Base w/Gasket
Base de la Manija con Empaque
Embase de manette avec Joint

Model / Modelo / Modèle T4795

RP72717▲
Lift Rod
Barra de alzar
Tige de Manoeuvre

RP72720▲
Handle Button (2) & Set Screw (2)
Botón de la manija (2) y Tornillo de Ajuste (2)
Vis de calage (2) et bouton de manette (2)

RP73284▲
Set Screw & Button
Tornillo de Presión y Botón
Vis de Calage et Bouton

RP41896
Glide Ring
Aro para Deslizar
L'anneau de Glissement

RP52593
Stream Straightener,
Gasket & Wrench
Enderezador del Chorro,
Empaque y Llave
Concentrateur de Jet,
Joint et Clé

RP72718▲
Spout Base w/Gasket
Base del Tubo de Salida
con Empaque
Embase du Bec avec Joint

RP72722▲
Handle Base, Nut & Gasket
Base de la Manija, Tuerca y Empaque
Base, écrou et joint de manette

RP62556▲
Conical Nut with O-Rings
Tuerca Cónica con Anillos "O"
Écrou conique avec Joints toriques

RP46680▲
Hand Piece
Pieza de Mano
Douche à main

RP72721▲
Hand Piece Base
Base para la Pieza de mano
Base de la douche à main

RP40664
Hose & Gaskets
Manguera y Empaques
Tuyau souple et joints

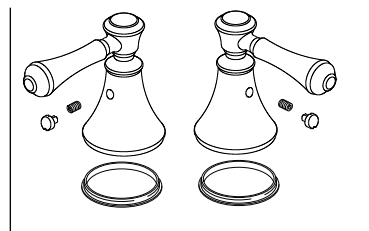

H697▲
Handle Assembly
Ensamble de la manija
Manette

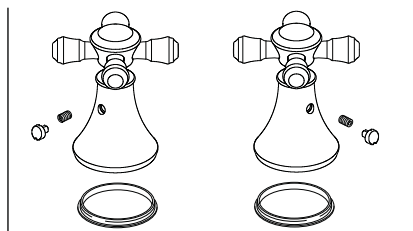

H695▲
Handle Assembly
Ensamble de la manija
Manette

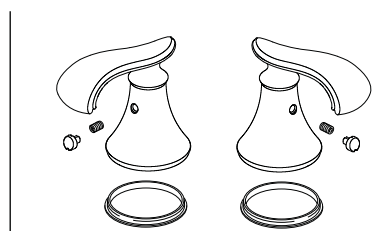

H698▲
Handle Assembly
Ensamble de la manija
Manette

Cassidy™ Roman Tub Trim Garniture de Bain Romain Cassidy™

Adorno Cassidy™ para Bañera Romana

Cassidy™ Roman Tub

Models/Modelos/Modèles T2797 & T4797 Series/Series/Seria

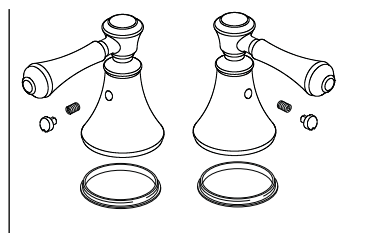
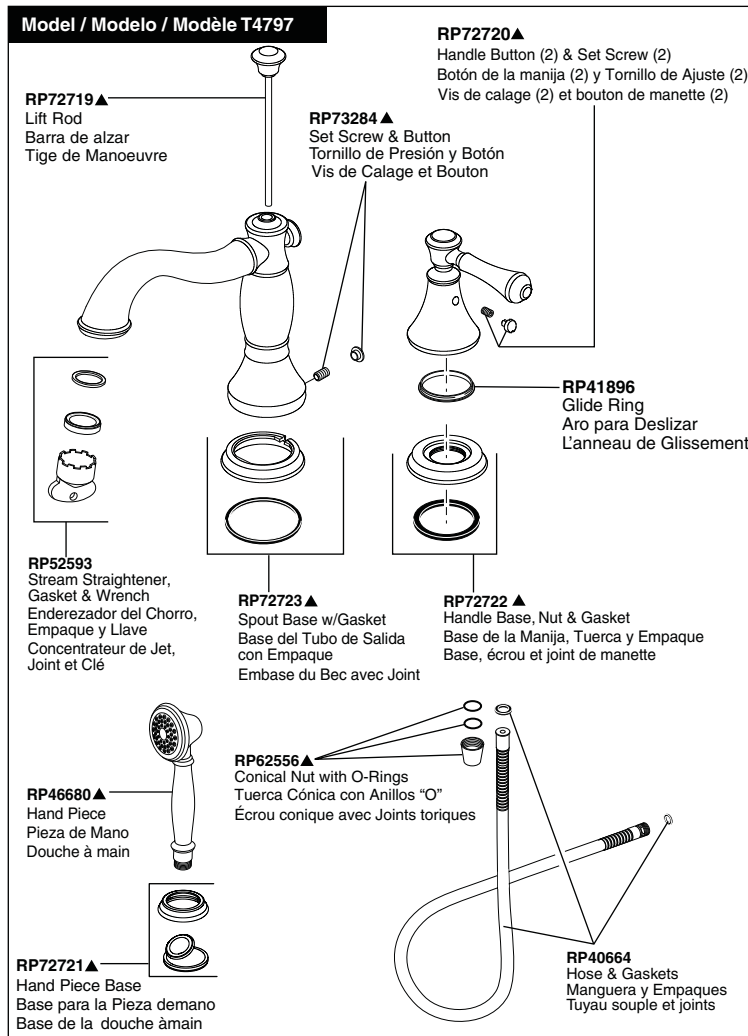
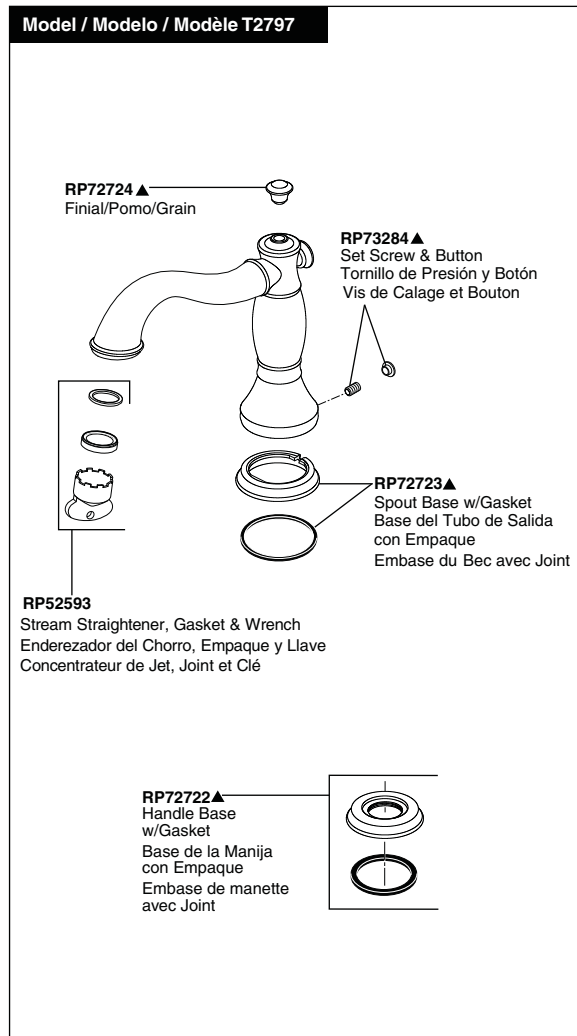

H697▲
Handle Assembly
Ensamble de la manija
Manette

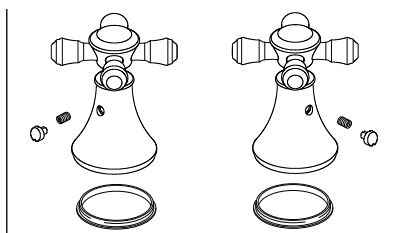

H695▲
Handle Assembly
Ensamble de la manija
Manette

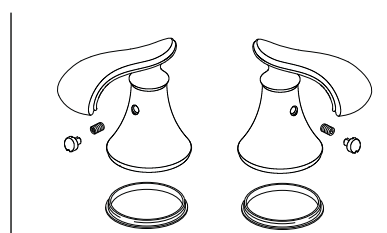

H698▲
Handle Assembly
Ensamble de la manija
Manette

Tub/Shower Valves Garniture pour Bain/Douche

Adorno para Bañera/Ducha

Models/Modelos/Modèles 144705 & 142705 Series/Series/Seria

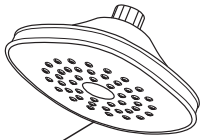

RP71015▲
Showerhead
Cabeza de Rogadora
Pomme de Douche

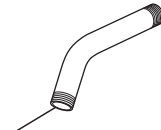

RP6023▲
Shower Arm
Brazo de la Rogadora
Tuyau de Pomme de Douche



RP71016▲
Shower Flange
Pestaña de la Rogadora
Collerette

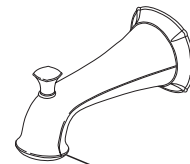
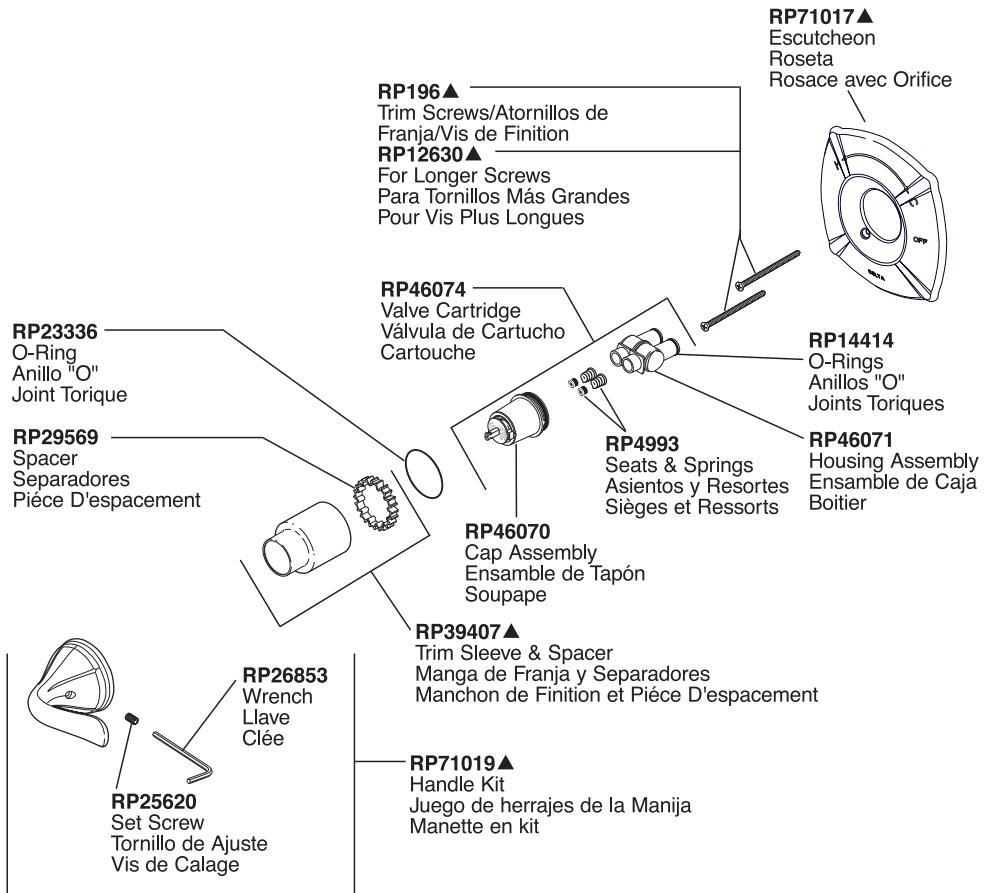

RP71018▲
Tub Spout/Pull-Up Diverter
Tubo de Salida para Bañera/
Botón Desviador de Alzar
Bec/avec dérivation à tirette

Compel Tub/Shower Trim Garniture pour Bain/Douche Compel

Adorno Compel para Bañera/Ducha

Compel Tub/Shower

Models/Modelos/Modèles T14061, T14261 & T14461 Series/Series/Seria



RP70175▲
Showerhead
Cabeza de Rogadora
Pomme de Douche



RP6023▲
Shower Arm
Brazo de la Rogadora
Tuyau de Pomme de Douche



RP6025▲
Shower Flange
Pestaña de la Rogadora
Collerette

RP73373▲
Escutcheon/seal
Roseta
Rosace avec Orifice

RP196▲
Trim Screws/Atornillos de
Franja/Vis de Finition
RP12630▲
For Longer Screws
Para Tornillos Más Grandes
Pour Vis Plus Longues

***RP46074**
Valve Cartridge
Válvula de Cartucho
Cartouche

RP14414
O-Rings
Anillos "O"
Joints Toriques

RP4993
Seats & Springs
Asientos y Resortes
Sièges et Ressorts

RP50879▲†
Trim Sleeve
Manga de Franja
Manchon de Finition

RP23336
O-Ring
Anillo "O"
Joint Torique

RP25620
Set Screw
Tornillo de Ajuste
Vis de Calage

RP73376▲
Handle Kit
Juego de herrajes
de la Manija
Manette en kit

RP26853
Wrench
Llave
Clé

RP73372▲
Tub Spout/Pull-Up Diverter
Tubo de Salida para Bañera/
Botón Desviador de Alzar
Bec/avec dérivation à tirette

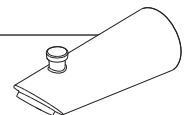

Compel Tub/Shower Trim Garniture pour Bain/Douche Compel

Adorno Compel para Bañera/Ducha

Compel™ Tub/Shower

Models/Modelos/Modèles T17061, T17261 & T17461 Series/Series/Seria



RP70175▲
Showerhead
Cabeza de Rogadora
Pomme de Douche



RP6023▲
Shower Arm
Brazo de la Rogadora
Tuyau de Pomme de Douche



RP6025▲
Shower Flange
Pestaña de la Rogadora
Collerette

RP73374▲
Escutcheon/seal
Roseta
Rosace avec Orifice

RP196▲
Trim Screws/Atornillos de Franja/Vis de Finition
RP12630▲
For Longer Screws
Para Tornillos Más Grandes
Pour Vis Plus Longues

***RP46463**
Cartridge Assembly
Cartucho
Cartouche

RP50880▲
Trim Sleeve
Manga de Franja
Manchon de Finition

RP73379▲
Handle Assembly
Ensamble de la Manija
Poignée

RP32105
Screw/Tornillo/Vis

NOTE: Do NOT overtighten screw.

NOTA: NO apriete demasiado el tornillo.

NOTE: NE serrez PAS trop la vis.

RP32102
Rotational Limit Stop
Tope para Limitar
Butée Rotative

RP23336
O-Ring
Anillo "O"
Joint Torique

RP73380▲
Temperature Knob and Cover
Perilla de la Temperatura y Cubierta
Poignée de Réglage de Température

RP73372▲
Tub Spout/Pull-Up Diverter
Tubo de Salida para Bañera/
Botón Desviador de Alzar
Bec/avec dérivation à tirette

Compel™ Roman Tub Trim Garniture de Bain Romain Compel™

Adorno Compel™ para Bañera Romana

Compel™ Roman Tub

Models/Modelos/Modèles T2761 & T4761 Series/Series/Seria

Model / Modelo / Modèle T2761

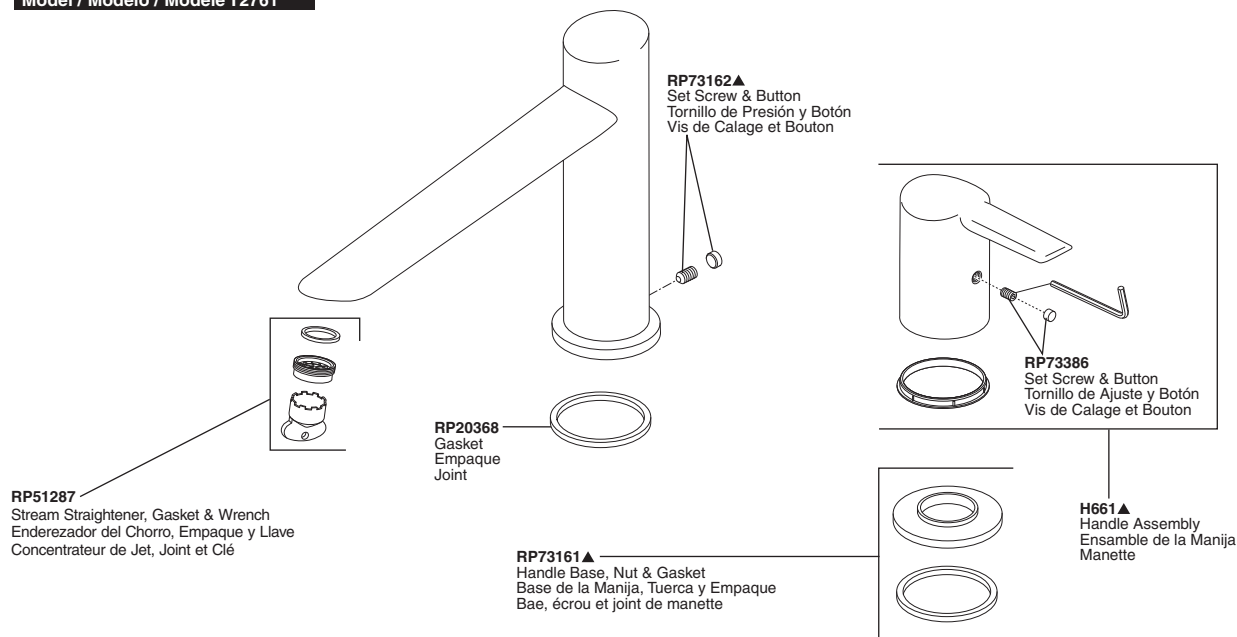

Model / Modelo / Modèle T4761

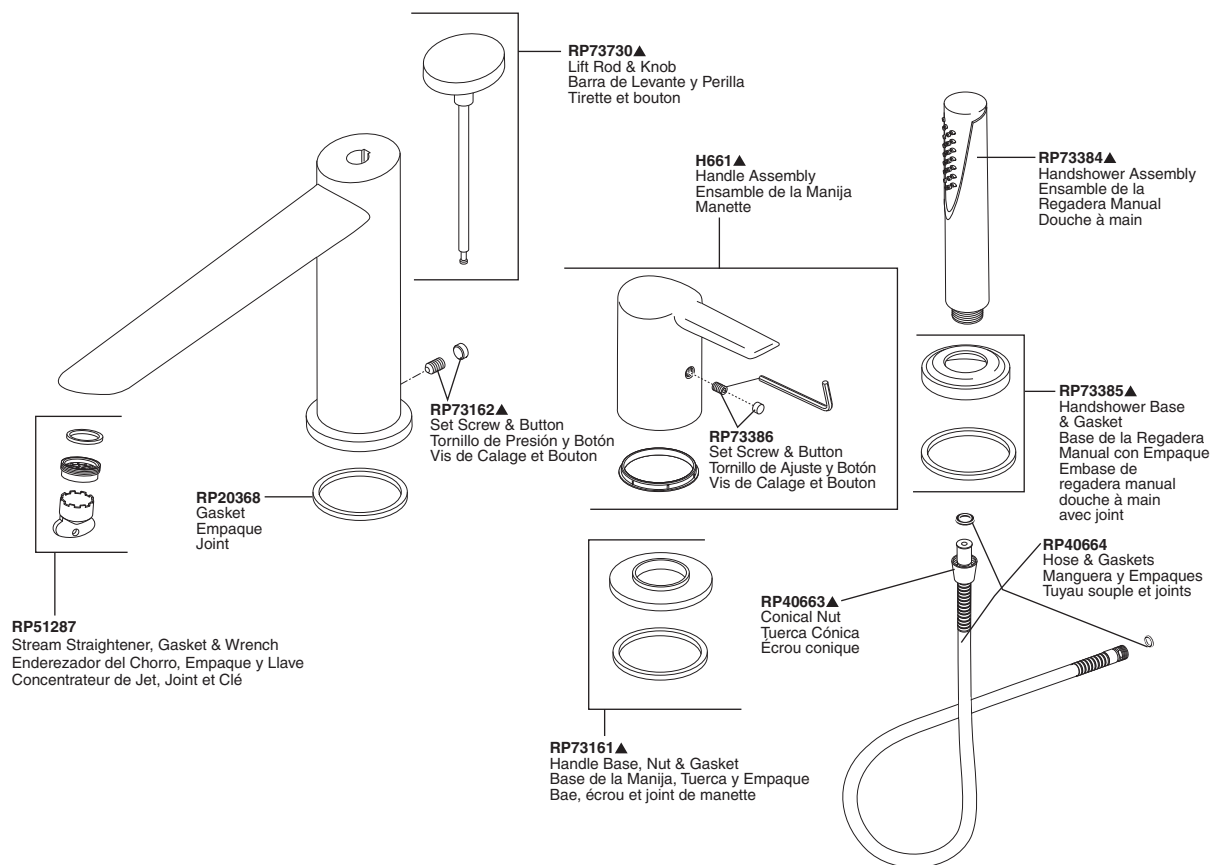

Dryden™ Tub/Shower Trim

Garniture pour Bain/Douche Dryden™

Adorno Dryden™ para Bañera/Ducha

Models/Modelos/Modèles T14051, T14251 & T14451 Series/Series/Seria

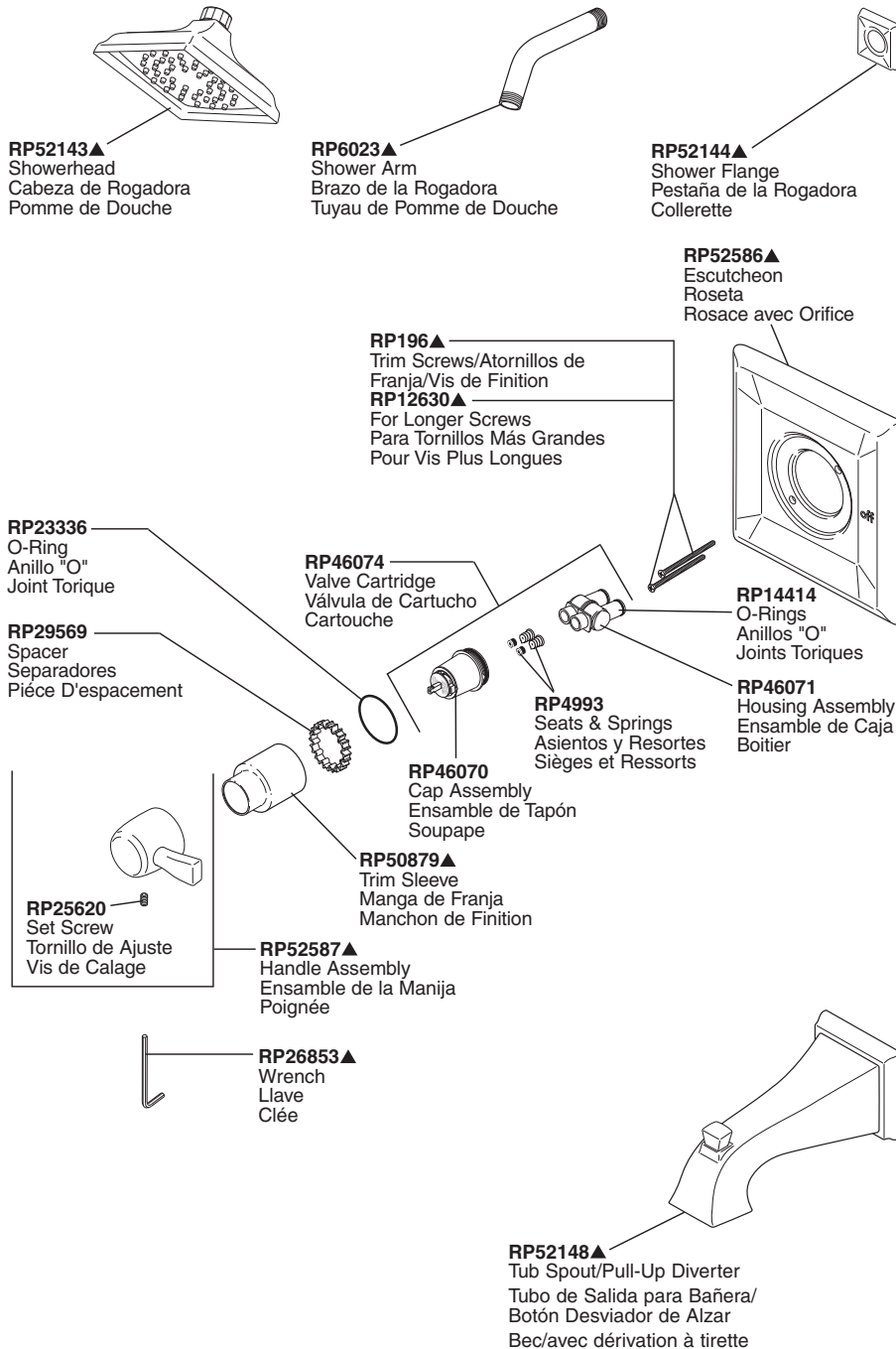

Tub/Shower Trim

Garniture pour Bain/Douche

Adorno para Bañera/Ducha

Dryden™ Tub/Shower

Models/Modelos/Modèles T17051, T17151, T17251, T17451,
T17251-H2O & T17451-H2O Series/Series/Seria



RP62283▲
Showerhead
Cabeza de Rogadora
Pomme de Douche

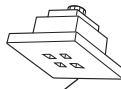

RP51032▲
Showerhead
Cabeza de Rogadora
Pomme de Douche



RP6023▲
Shower Arm
Brazo de la Rogadora
Tuyau de Pomme de Douche



RP52144▲
Shower Flange
Pestaña de la Rogadora
Collerette

RP32105
Screw/Tornillo/Vis

NOTE: Do NOT overtighten screw
NOTA: NO apriete demasiado el tornillo
NOTE: NE serrez PAS trop la vis

RP32102
Rotational Limit Stop
Tope para Limitar
Butée Rotative

RP52147▲
Temperature Knob and Cover
Perilla de la Temperatura y Cubierta
Poignée de Réglage de Température

RP37731▲
Trim Sleeve
Manga de Franja
Manchon de Finition

RP52146▲
Handle Assembly
Ensamble de la Manija
Poignée

RP196▲
Trim Screws/Atornillos de
Franja/Vis de Finition

RP12630▲
For Longer Screws
Para Tornillos Más Grandes
Pour Vis Plus Longues

★ RP46463
Cartridge Assembly
Cartucho
Cartouche

RP23336
O-Ring
Anillo "O"
Joint Torique

RP28598
Decal (Red/Blue)
Etiqueta (Rojo/Azul)
Etiquette (Rouge/Bleu)

RP52588▲
Escutcheon
Roseta
Rosace avec Orifice

RP52148▲
Tub Spout-Pull-Up Diverter
Tubo de Salida para Bañera-
Botón Desviador de Alzar
Bec avec dérivation à tirette

Tub/Shower Trim Garniture pour Bain/Douche

Adorno para Bañera/Ducha

Dryden™ Tub/Shower

Models/Modelos/Modèles T17T051, T17T251 & T17T451 Series/Series/Seria

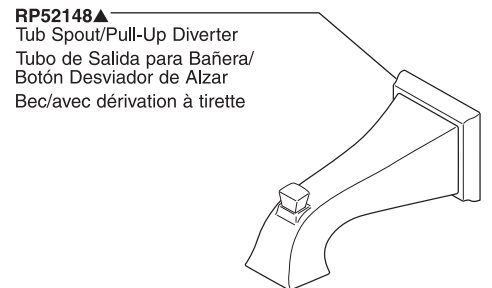
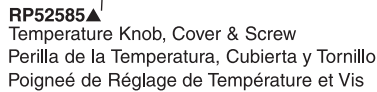
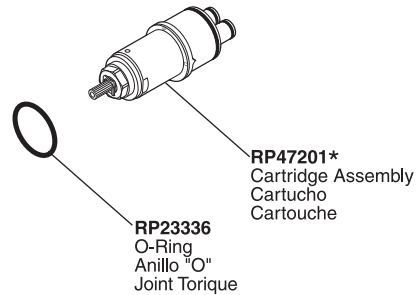
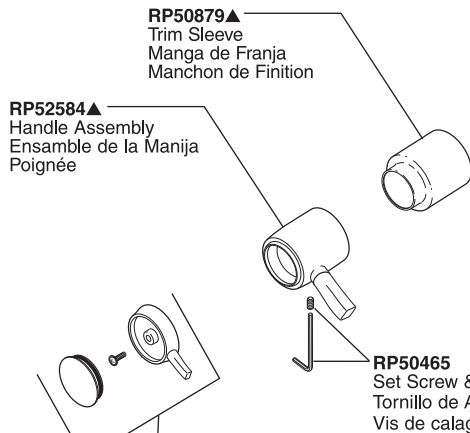
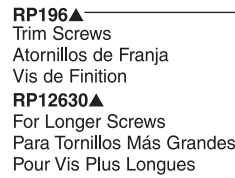
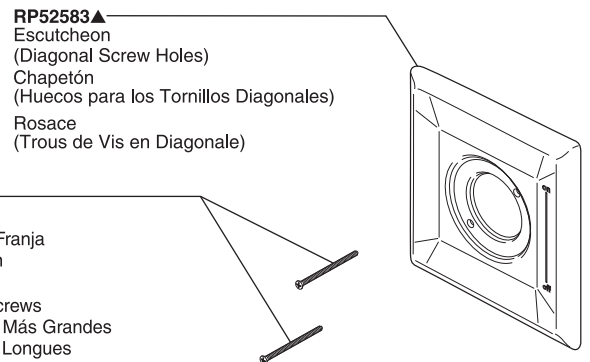
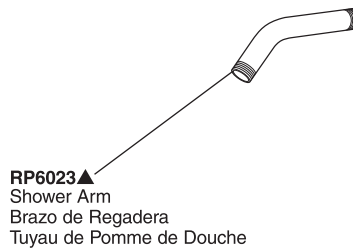
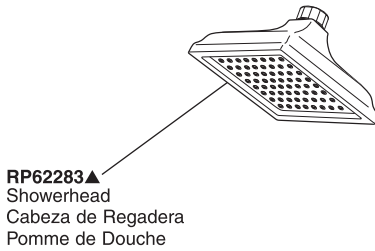

Dryden™ Roman Tub Trim Garniture de Bain Romain Dryden™

Adorno Dryden™ para Bañera Romana

Dryden™ Roman Tub

Models/Modelos/Modèles T2751 & T4751 Series/Series/Seria

Model / Modelo / Modèle T2751

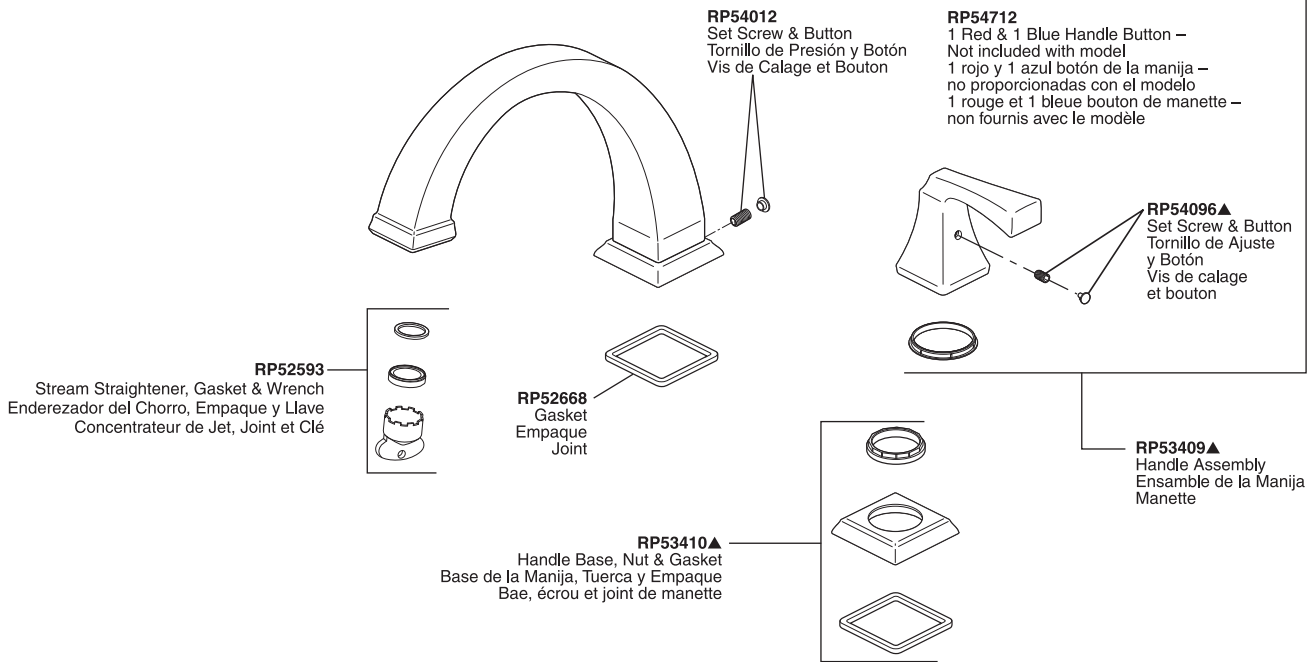

Model / Modelo / Modèle T4751

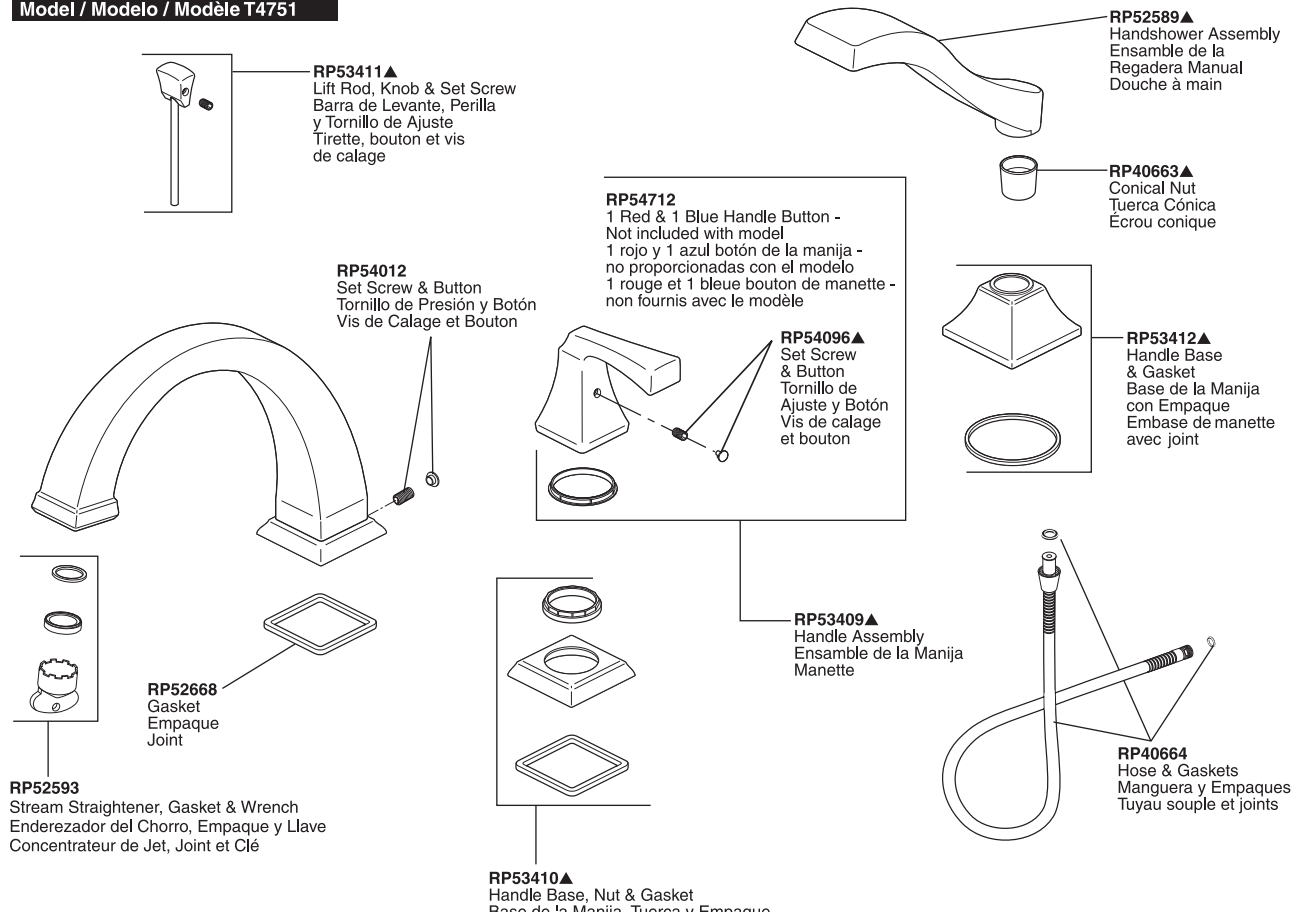

▲ Specify finish / Especificque el Acabado / Précisez le fini

Ellington® Tub/Shower Trim Garniture pour Bain/Douche Ellington®

Adorno Ellington® para Banera/Ducha

Models/Modelos/Modèles T14169, T14269 & T14469 Series/Series/Seria

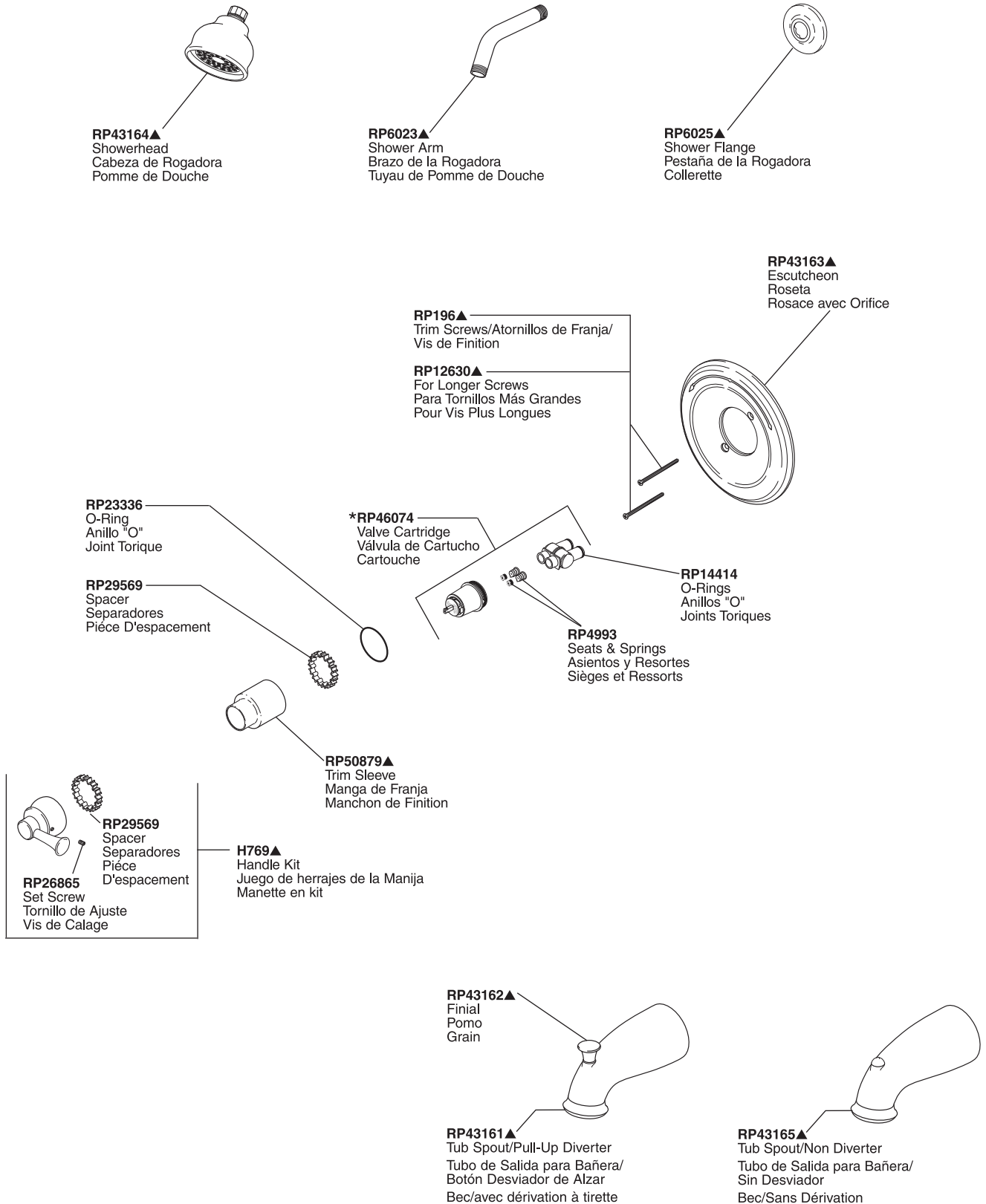

▲ Specify finish / Especificque el Acabado / Précisez le fini

Single-Handle Pressure Balanced Bath Valve Robinet de Bañoire à Équilibrée à une Manette

Válvulas de Bañeras de Manija Sencilla de Presión Balanceada

Models/Modelos/Modèles B112900 & B114900 Series/Series/Seria

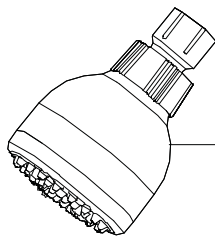

RP74150▲
Showerhead
Cabezal ed ducha
Pomme de douche

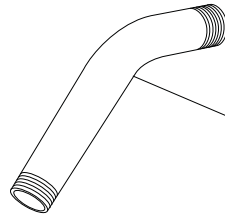

RP6023▲
Shower Arm
Brazo de Regadera
Pomme de douche



RP6025▲
Flange
Brida
collerette

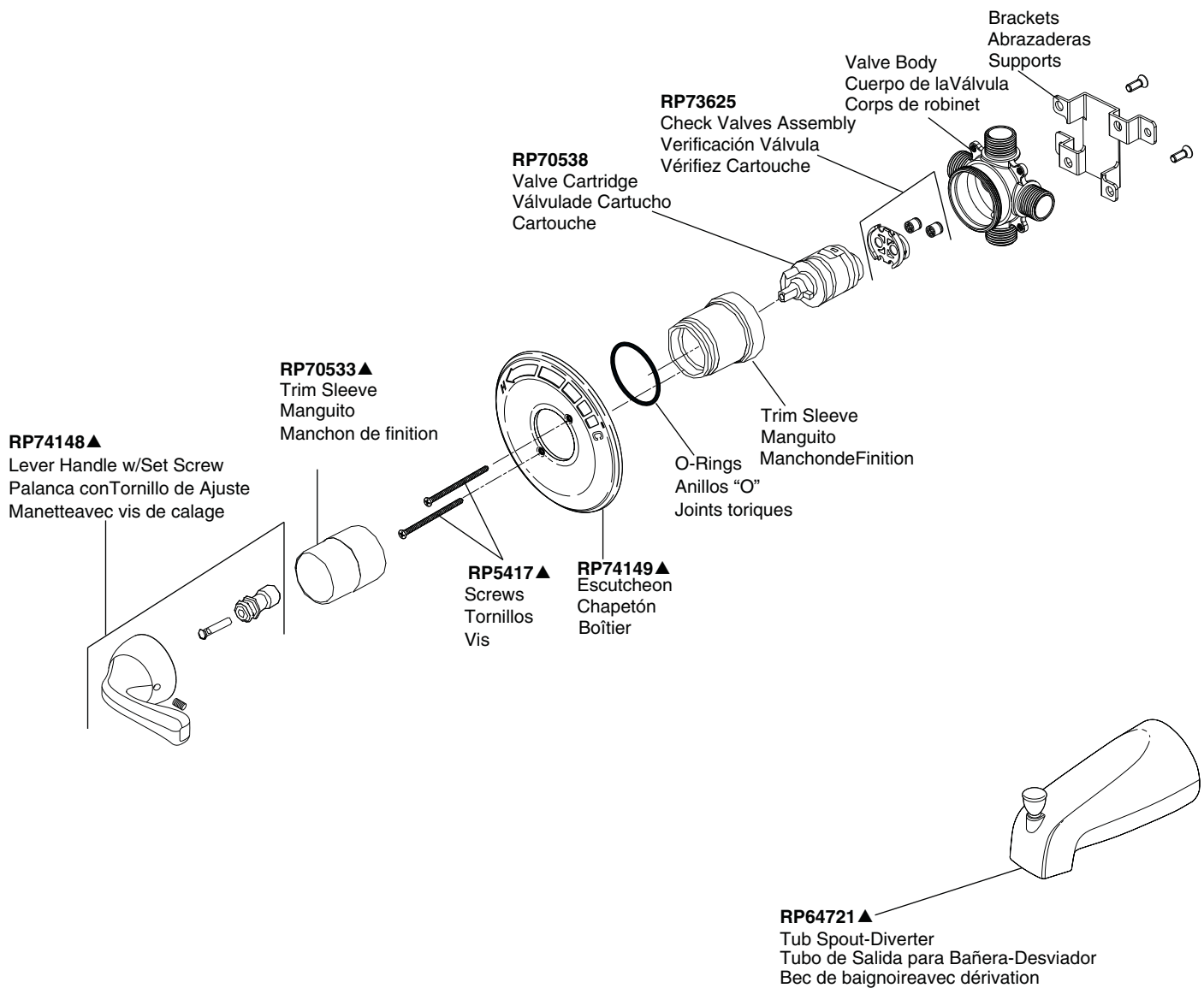

Foundations™ Tub/Shower Trim Garniture pour Bain/Douche Foundations™

Adorno Foundations™ para Bañera/Ducha

Models/Modelos/Modèles BT13010, BT13210 & BT13410 Series/Series/Seria



RP44809▲
Showerhead
Cabeza de Regadera
Pomme de douche



RP6023▲
Shower Arm
Brazo de Regadera
Tuyau de Pomme de Douche



RP6025▲
Shower Flange
Pestaña de la Regadera
Collerette

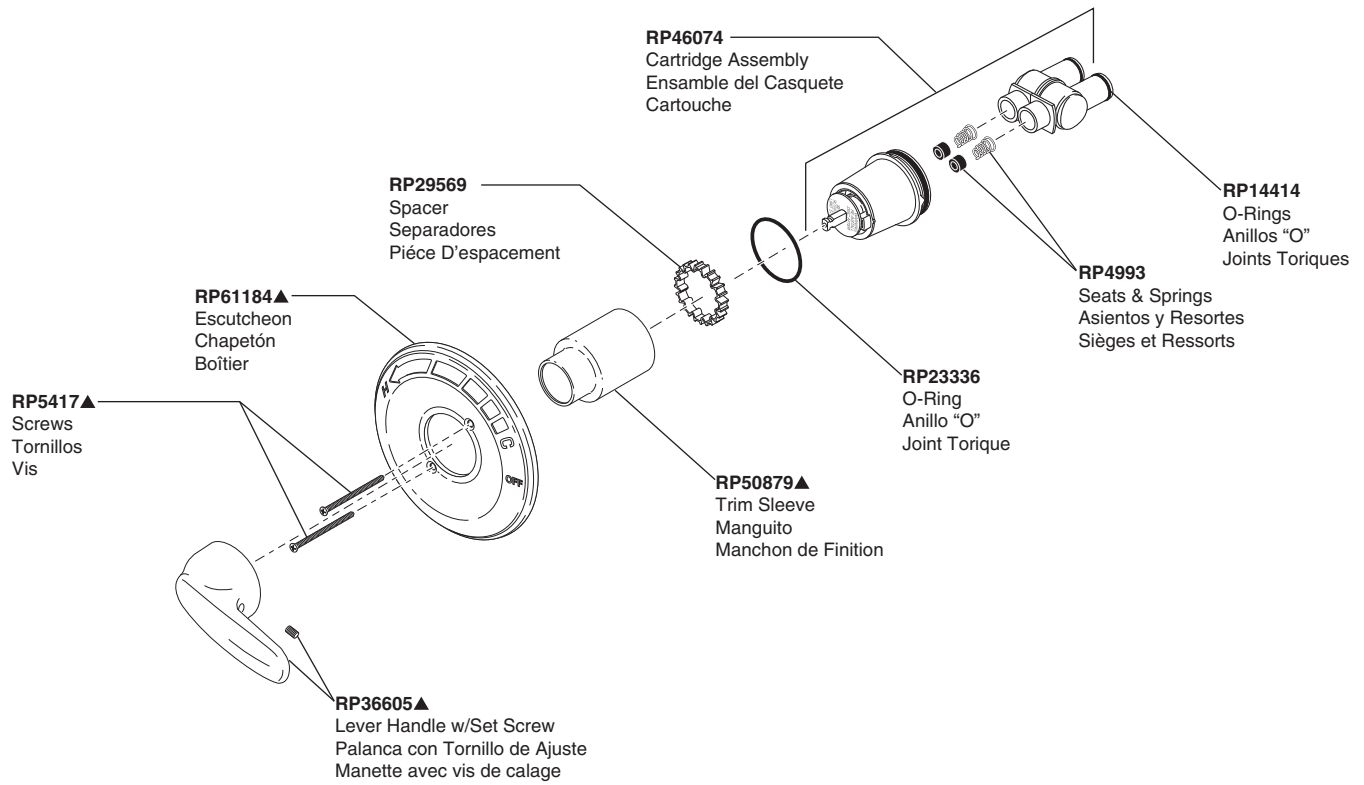

RP62149▲
Tub Spout / Non Diverter
Tubo de Salida para Bañera / Sin Desviador
Bec / Sans Dérivation

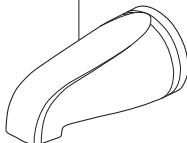

RP61357▲
Tub Spout / Diverter
Tubo de Salida para Bañera / Desviador
Bec de Baignoire / Avec Dérivation

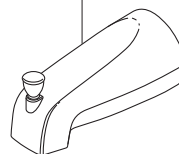

Foundations™ Tub/Shower Trim Garniture pour Bain/Douche Foundations™

Adorno Foundations™ para Bañera/Ducha

Foundations™ Tub/Shower

Models/Modelos/Modèles BT14096, BT14296 & BT14496 Series/Series/Seria

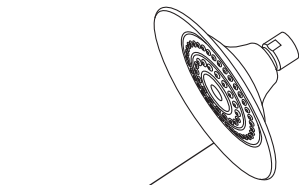

RP61181 ▲
Showerhead
Cabeza de Regadera
Pomme de douche

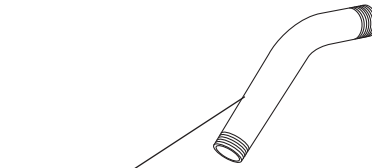

RP6023 ▲
Shower Arm
Brazo de Regadera
Tuyau de Pomme de Douche



RP6025 ▲
Shower Flange
Pestaña de la Regadera
Collerette

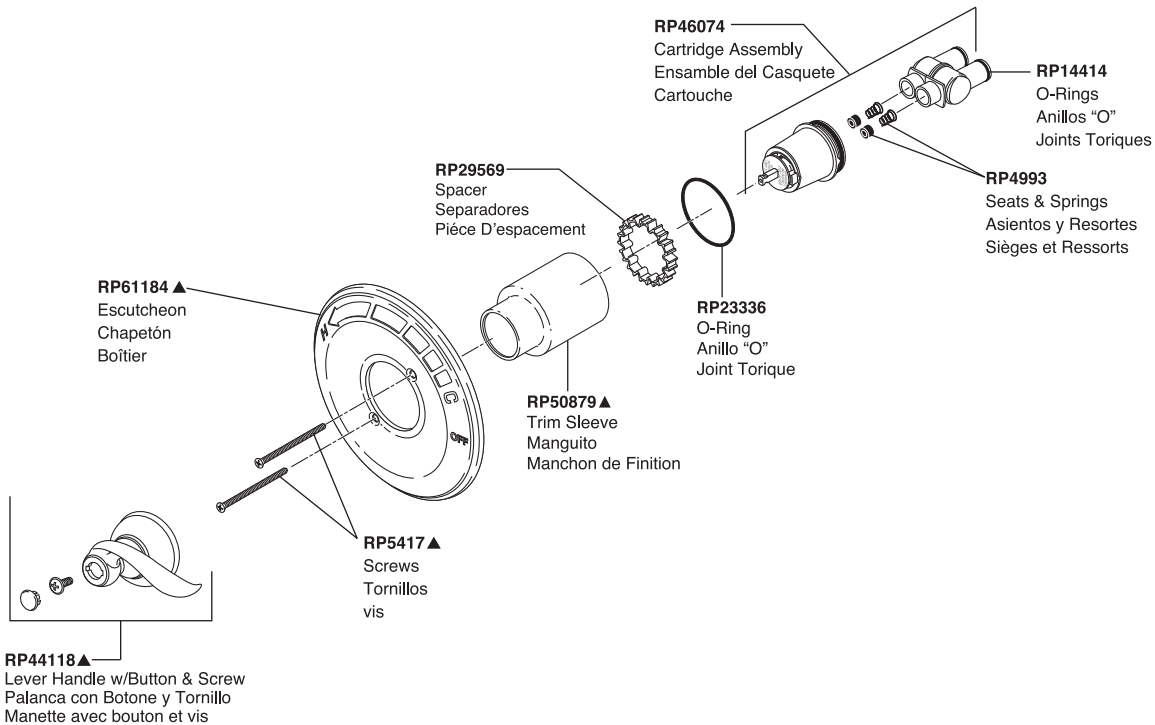

RP46074
Cartridge Assembly
Ensamble del Casquete
Cartouche

RP14414
O-Rings
Anillos "O"
Joints Toriques

RP29569
Spacer
Separadores
Pièce D'espacement

RP4993
Seats & Springs
Asientos y Resortes
Sièges et Ressorts

RP61184 ▲
Escutcheon
Chapetón
Boîtier

RP23336
O-Ring
Anillo "O"
Joint Torique

RP50879 ▲
Trim Sleeve
Manguito
Manchon de Finition

RP5417 ▲
Screws
Tornillos
vis

RP44118 ▲
Lever Handle w/Button & Screw
Palanca con Botone y Tornillo
Manette avec bouton et vis

RP64722 ▲
Tub Spout / Non Diverter / Slip-on
Tubo de Salida para Bañera / Sin Desviador / Deslizable
Bec / Sans Dérivation/ D'un bec coulissant

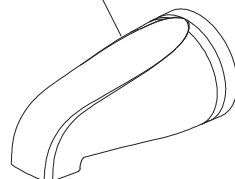

RP64721 ▲
Tub Spout-Diverter / Slip-on
Tubo de Salida para Bañera-Desviador / Deslizable
Bec de baignoire avec dérivation / D'un bec coulissant

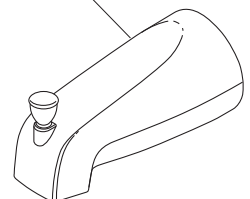

Windemere™ Single-Handle Pressure Balanced Bath Valve

Robinet de Bañoire à Équilibrée Windemere™ à une Manette

Válvulas de Bañeras de Manija Sencilla Windemere™ de Presión Balanceada

Windemere™ Tub/Shower

Models/Modelos/Modèles 142996 & 144996 Series/Series/Seria

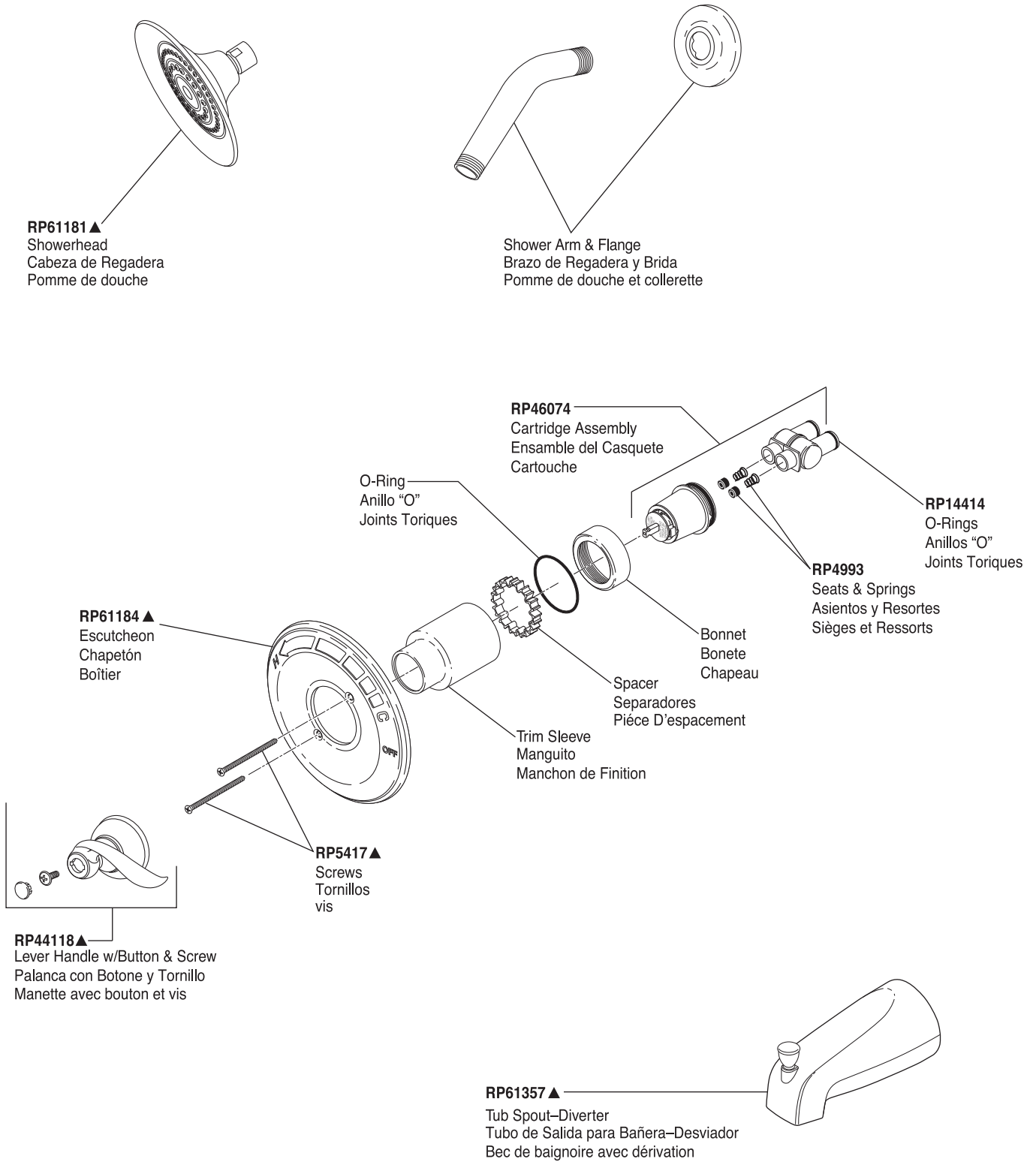

Foundations™ Roman Tub Trim Garniture de Bain Romain Foundations™

Adorno Foundations® para Bañera Romana

Model/Modelo/Modèle BT2710 Series/Series/Seria

Roman Tub Trim

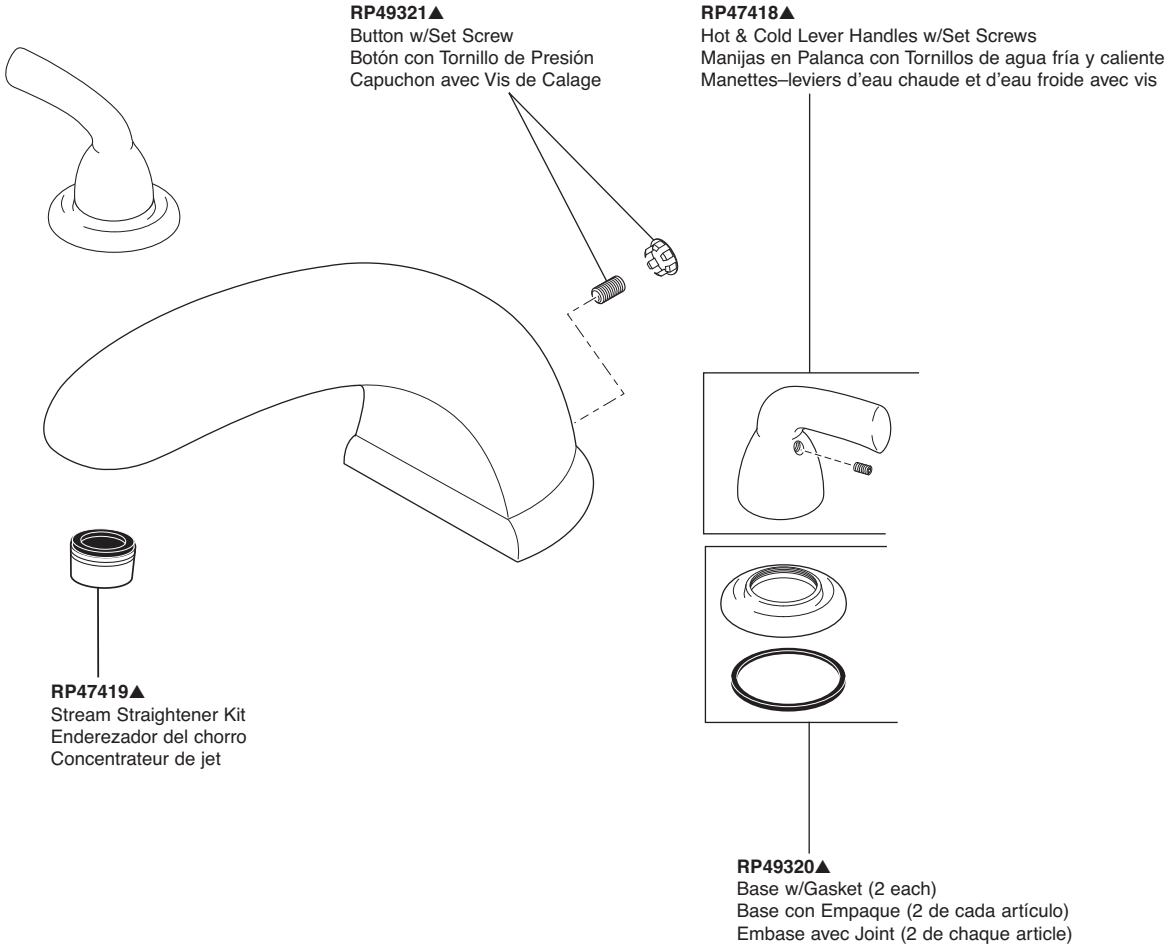

Foundations™ Roman Tub Trim Garniture de Bain Romain Foundations™

Adorno Foundations® para Bañera Romana

Foundations Roman Tub

Models/Modelos/Modèles BT2796 Series/Series/Seria

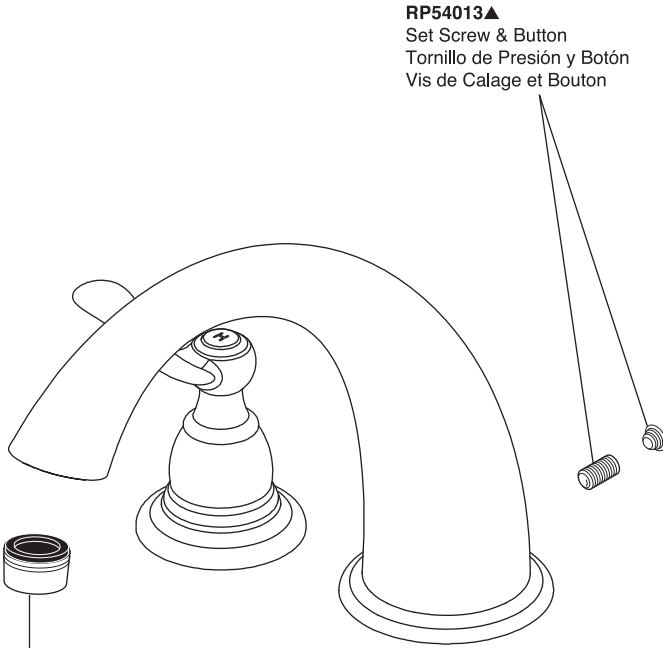

RP54013▲
Set Screw & Button
Tornillo de Presión y Botón
Vis de Calage et Bouton

RP47419▲
Stream Straightener Kit
Enderezador del chorro
Concentrateur de jet

RP62150▲
Hot & Cold "S" Lever Handles
w/Buttons & Screws
Manijas en Palanca en 'S' con Botones
y Tornillos de agua fría y caliente
Manettes-leviers d'eau chaude et d'eau
froide en S avec boutons

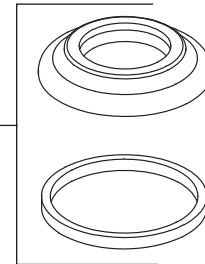
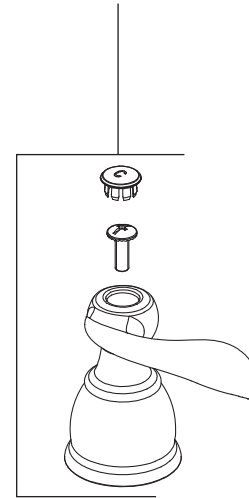

RP62151▲
Base w/Gasket (2 each)
Base con Empaque (2 de cada artículo)
Embase avec Joint (2 de chaque article)

Grail® & Rizu™ Tub/Shower Trim

Garniture pour Bain/Douche Grail® & Rizu™

Adorno Grail® & Rizu™ para Bañera/Ducha

Grail & Rizu Tub/Shower

Models/Modelos/Modèles T14082, T14085, T14185, T14282, T14285, T14285-H2O, T14482, T14485 & T14485-H2O Series/Series/Seria



RP52382▲
Showerhead
Cabeza de Rogadora
Pomme de Douche



RP48590▲
Showerhead
Cabeza de Rogadora
Pomme de Douche



RP70175▲
Showerhead
Cabeza de Rogadora
Pomme de Douche

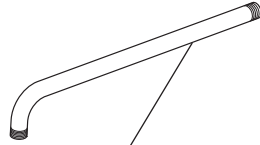

RP46870▲
Shower Arm
Brazo de la Rogadora
Tuyau de Pomme
de Douche

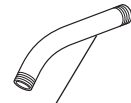

RP40593▲
Shower Arm
Brazo de la Rogadora
Tuyau de Pomme
de Douche



RP40592▲
Shower Flange
Pestaña de la Rogadora
Collerette

RP196▲
Trim Screws/Atornillos de Franja/
Vis de Finition

RP12630▲
For Longer Screws
Para Tornillos Más Grandes
Pour Vis Plus Longues

RP48716▲
Escutcheon
Roseta
Rosace avec Orifice

RP23336
O-Ring
Anillo "O"
Joint Torique

RP29569
Spacer
Separadores
Pièce D'espacement

***RP46074**
Valve Cartridge
Válvula de Cartucho
Cartouche

RP14414
O-Rings
Anillos "O"
Joints Toriques

RP4993
Seats & Springs
Asientos y Resortes
Sièges et Ressorts

RP50879▲†
Trim Sleeve
Manga de Franja
Manchon de Finition

RP26865
Set Screw
Tornillo de Ajuste
Vis de Calage

RP48592▲
Handle Kit
Juego de herrajes de la Manija
Manette en kit

RP26865
Set Screw
Tornillo de Ajuste
Vis de Calage

RP48591▲
Handle Kit
Juego de herrajes de la Manija
Manette en kit

RP40625▲
Tub Spout/Pull-Up Diverter
Tubo de Salida para Bañera/
Botón Desviador de Alzar
Bec/avec dérivation à tirette

RP41594▲
Tub Spout/Non Diverter
Tubo de Salida para Bañera/
Sin Desviador
Bec/Sans Dérivation

RP48718▲
Tub Spout/Pull-Up Diverter
Tubo de Salida para Bañera/
Botón Desviador de Alzar
Bec/avec dérivation à tirette

RP19820▲
Tub Spout/Pull-Up Diverter
Tubo de Salida para Bañera/
Botón Desviador de Alzar
Bec/avec dérivation à tirette

Tub/Shower Trim Garniture pour Bain/Douche

Adorno para Bañera/Ducha

Models/Modelos/Modèles T17082, T17085, T17282, T17285, T17482, T17485,
T17285-H2O & T17485-H2O Series/Series/Seria



RP48590▲
Showerhead
Cabeza de Rogadora
Pomme de Douche



RP70175▲
Showerhead
Cabeza de Rogadora
Pomme de Douche



RP46870▲
Shower Arm
Brazo de la Rogadora
Tuyau de Pomme de Douche



RP40593▲
Shower Arm
Brazo de la Rogadora
Tuyau de Pomme de Douche



RP40592▲
Shower Flange
Pestaña de la Rogadora
Collerette



RP52382▲
Shower Arm
Brazo de la Rogadora
Tuyau de Pomme de Douche

RP196▲
Trim Screws
Atornillos de Franja
Vis de Finition
RP12630▲
For Longer Screws
Para Tornillos Más Grandes
Pour Vis Plus Longues

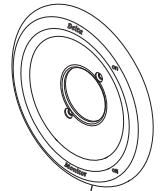

RP28795▲
Escutcheon
Roseta
Rosace avec Orifice

RP32105
Screw/Tornillo/Vis

NOTE: Do NOT overtighten screw
NOTA: NO apriete demasiado el tornillo
NOTE: NE serrez PAS trop la vis

*** RP46463**
Cartridge Assembly
Cartucho
Cartouche

RP50880▲
Trim Sleeve
Manga de Franja
Manchon de Finition

RP28598
Decal (Red/Blue)
Etiqueta (Rojo/Azul)
Etiquette (Rouge/Bleu)

RP32102
Rotational Limit Stop
Tope para Limitar
Butée Rotative

RP23336
O-Ring
Anillo "O"
Joint Torique

RP53414▲
Handle Assembly
Ensamble de la Manija
Poignée

RP40625▲
Tub Spout/Pull-Up Diverter
Tubo de Salida para Bañera/
Botón Desviador de Alzar
Bec/avec dérivation à tirette

RP53413▲
Temperature Knob and Cover
Perilla de la Temperatura y Cubierta
Poignée de Réglage de Température

RP61610▲
Handle Assembly
Ensamble de la Manija
Poignée

RP28598
Decal (Red/Blue)
Etiqueta (Rojo/Azul)
Etiquette (Rouge/Bleu)

RP48718▲
Tub Spout/Pull-Up Diverter
Tubo de Salida para Bañera/
Botón Desviador de Alzar
Bec/avec dérivation à tirette

Tub/Shower Trim Garniture pour Bain/Douche

Adorno para Bañera/Ducha

Models/Modelos/Modèles T17T082, T17T085, T17T282, T17T285, T17T482 & T17T485 Series/Series/Seria



RP48590▲
Showerhead
Cabeza de Regadera
Pomme de Douche



RP46870▲
Shower Arm
Brazo de Regadera
Tuyau de Pomme de Douche

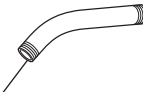

RP40593▲
Shower Arm
Brazo de Regadera
Tuyau de Pomme de Douche



RP40592▲
Shower Flange
Pestaña de la Regadera
Collerette



RP52382▲
Showerhead
Cabeza de Regadera
Pomme de Douche

RP48307▲
Escutcheon
(Diagonal Screw Holes)
Chapetón
(Huecos para los Tornillos Diagonales)
Rosace
(Trous de Vis en Diagonale)

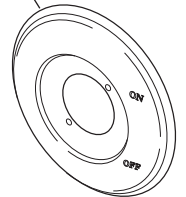

RP50879▲
Trim Sleeve
Manga de Franja
Manchon de Finition



RP53416▲
Handle Assembly
Ensamble de la Manija
Poignée



RP50465
Set Screw & Wrench
Tornillo de Ajuste y Llave
Vis de calage et Clé

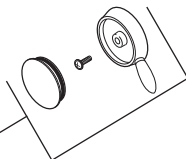

RP47201*
Cartridge Assembly
Cartucho
Cartouche



RP23336
O-Ring
Anillo "O"
Joint Torique



RP196▲
Trim Screws
Atornillos de Franja
Vis de Finition

RP12630▲
For Longer Screws
Para Tornillos Más Grandes
Pour Vis Plus Longues

RP53415▲
Temperature Knob, Cover & Screw
Perilla de la Temperatura, Cubierta y Tornillo
Poigné de Réglage de Température et Vis

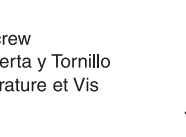

RP61612▲
Handle Assembly
Ensamble de la Manija
Poignée



RP61611▲
Temperature Knob, Cover & Screw
Perilla de la Temperatura, Cubierta y Tornillo
Poigné de Réglage de Température et Vis



RP40625▲
Tub Spout/Pull-Up Diverter
Tubo de Salida para Bañera/
Botón Desviador de Alzar
Bec/avec dérivation à tirette

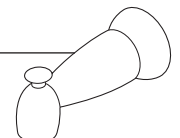

RP48718▲
Tub Spout/Pull-Up Diverter
Tubo de Salida para Bañera/
Botón Desviador de Alzar
Bec/avec dérivation à tirette

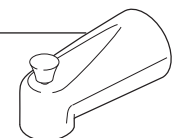

Grail® Roman Tub Trim Garniture de Bain Romain Grail®

Adorno Grail® para Bañera Romana

Model/Modelo/Modèle T2785 Series/Series/Seria

2785 Grail®

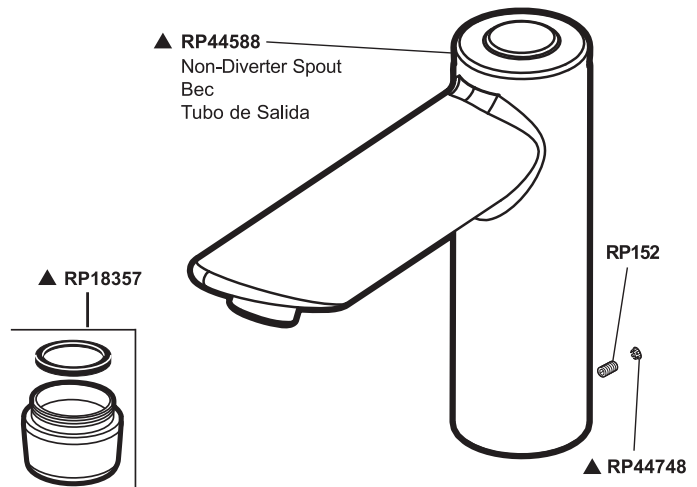
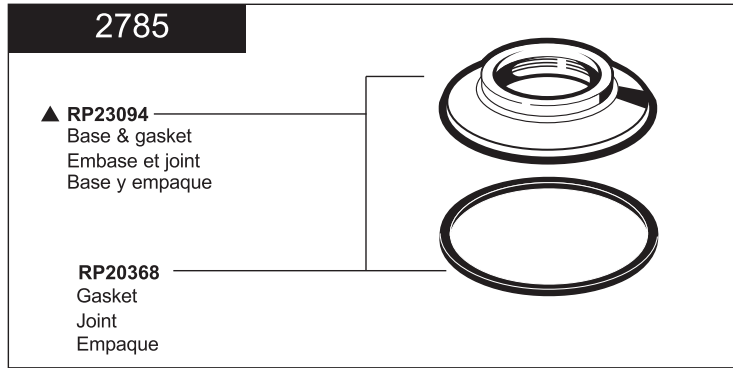
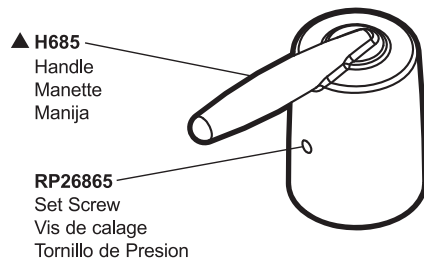

Innovations® Tub/Shower Trim Garniture pour Bain/Douche Innovations®

Adorno Innovations® para Bañera/Ducha

Innovations® Tub/Shower

Models/Modelos/Modèles T14030-LHP, T14130-LHP,
T14230-LHP & T14430-LHP Series/Series/Seria



RP40594▲
Showerhead
Cabeza de Rogadora
Pomme de Douche

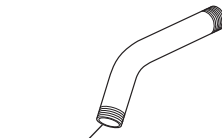

RP6023▲
Shower Arm
Brazo de la Rogadora
Tuyau de Pomme de Douche



RP38452▲ †
Shower Flange
Pestaña de la Rogadora
Collerette

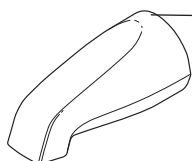
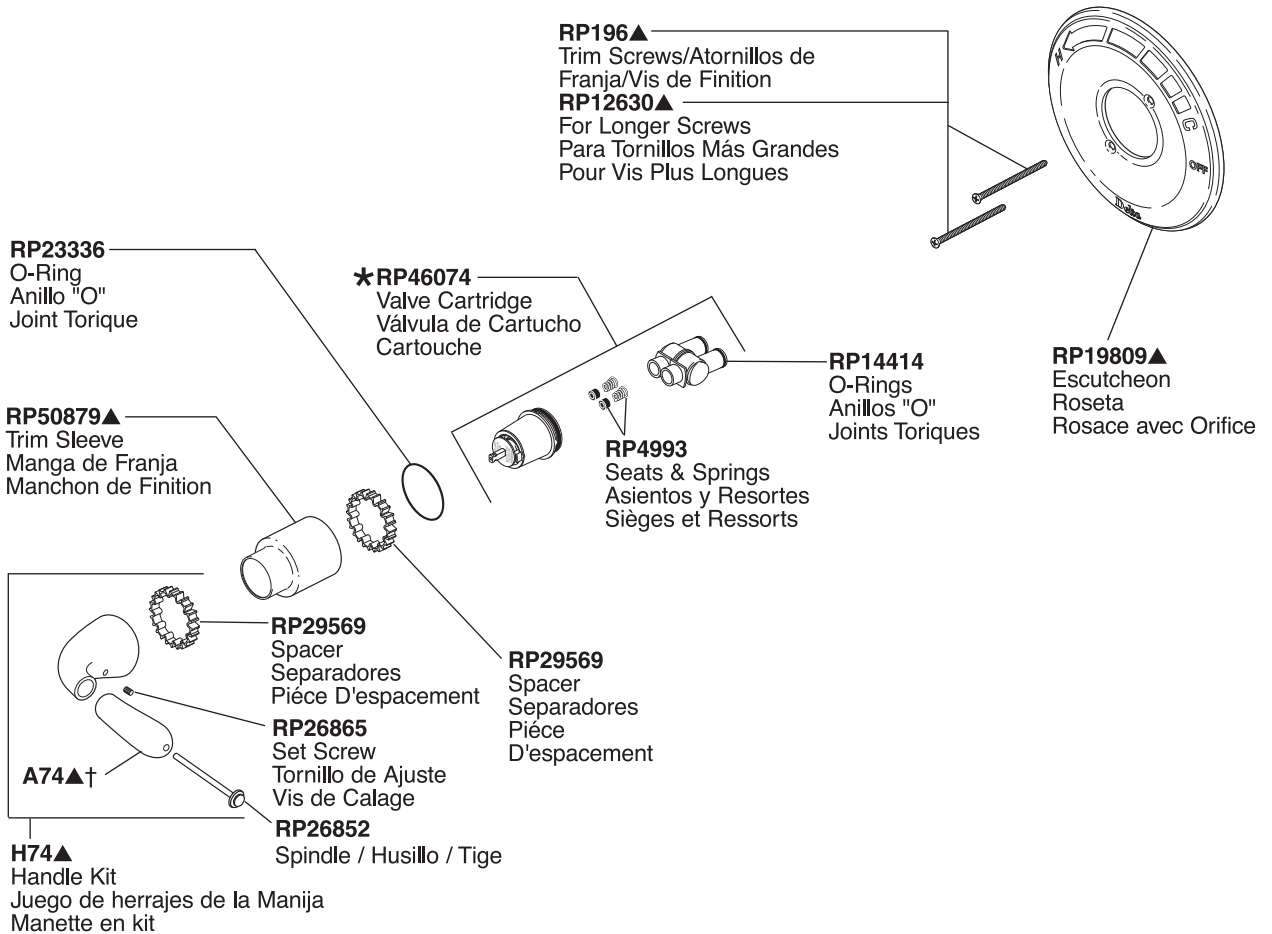

RP5833▲
Tub Spout/Non Diverter
Tubo de Salida para Bañera/
Sin Desviador
Bec/Sans Dérivation

RP17453
RP17454▲ (Metal/Metálico/Métal)
Tub Spout/Pull-Down Diverter
Tubo de Salida para Bañera/
Desviador de Halar
Bec/Avec Dérivation
sur Embout

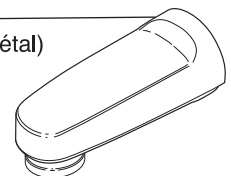

Innovations® Tub/Shower Trim Garniture pour Bain/Douche Innovations®

Adorno Innovations® para Bañera/Ducha

Innovations Tub/Shower

Models/Modelos/Modèles T17030, T17230, T17230-H2O, T17430 & T17430-H2O Series/Series/Seria



RP70173▲
Showerhead
Cabeza de Rogadora
Pomme de Douche



RP43381▲
Showerhead
Cabeza de Rogadora
Pomme de Douche



RP6023▲
Shower Arm
Brazo de la Rogadora
Tuyau de Pomme de Douche



RP6025▲†
Shower Flange
Pestaña de la Rogadora
Collerette

† Designates the accent color on split finish models.
† Designa el color para acentuar los modelos con acabados divididos.
† Désigne la couleur contrastante sur les modèles à deux finis.

RP28795▲
Escutcheon
Roseta
Rosace avec Orifice

RP196▲
Trim Screws/Atornillos de
Franja/Vis de Finition
RP12630▲
For Longer Screws
Para Tornillos Más Grandes
Pour Vis Plus Longues

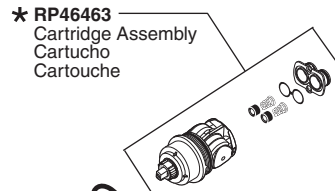

*** RP46463**
Cartridge Assembly
Cartucho
Cartouche

RP23336
O-Ring
Anillo "O"
Joint Torique

RP73643▲
Handle Assembly
Ensamble de la Manija
Poignée

RP32105
Screw/Tornillo/Vis
NOTE: Do NOT overtighten screw.
NOTA: NO apriete demasiado el tornillo.
NOTE: NE serrez PAS trop la vis.

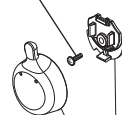

RP32102
Rotational Limit Stop
Tope para Limitar
Butée Rotative

RP73642▲
Temperature Knob and Cover
Perilla de la Temperatura y Cubierta
Poignée de Réglage de Température

RP50880▲†
Trim Sleeve
Manga de Franja
Manchon de Finition

RP5833▲ (Metal/Metálico/Métal)
Tub Spout/Non Diverter
Tubo de Salida para Bañera/
Sin Desviador
Bec/Sans Dérivation

RP17453
RP17454▲ (Metal/Metálico/Métal)
Tub Spout/Pull-Down Diverter
Tubo de Salida para Bañera/
Desviador de Halar
Bec/Avec Dérivation sur Embout

Innovations® Tub/Shower Trim Garniture pour Bain/Douche Innovations®

Adorno Innovations® para Bañera/Ducha

Innovations® Tub/Shower

Models/Modelos/Modèles T17T030, T17T230 & T17T430 Series/Series/Seria

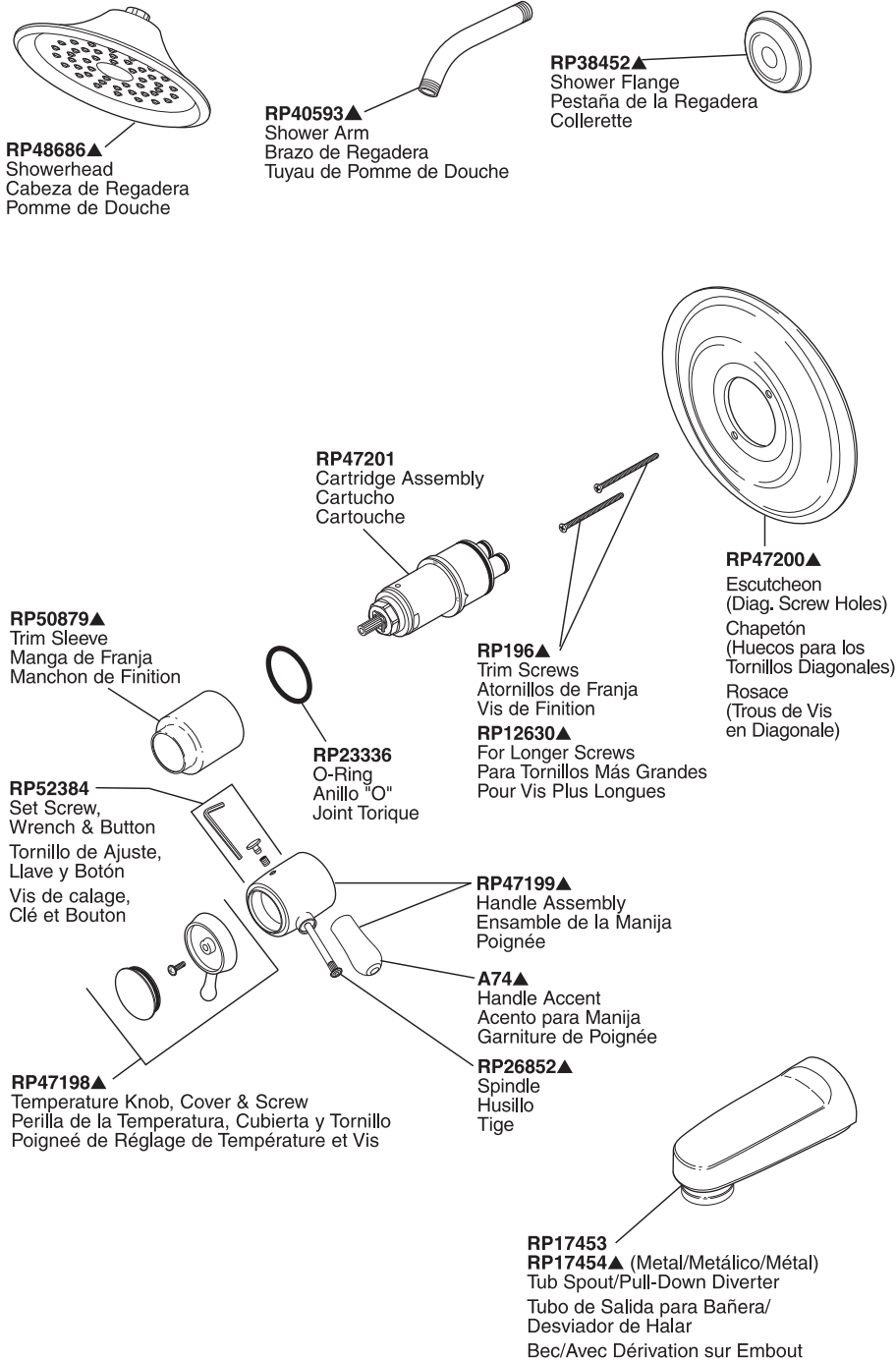

Innovations® Jetted Shower™ Trim Garniture Jetted Shower™ Innovations®

Adorno Innovations® para Jetted Shower™

Innovations® Jetted Shower™

Models/Modelos/Modèles T18430 Series/Series/Seria

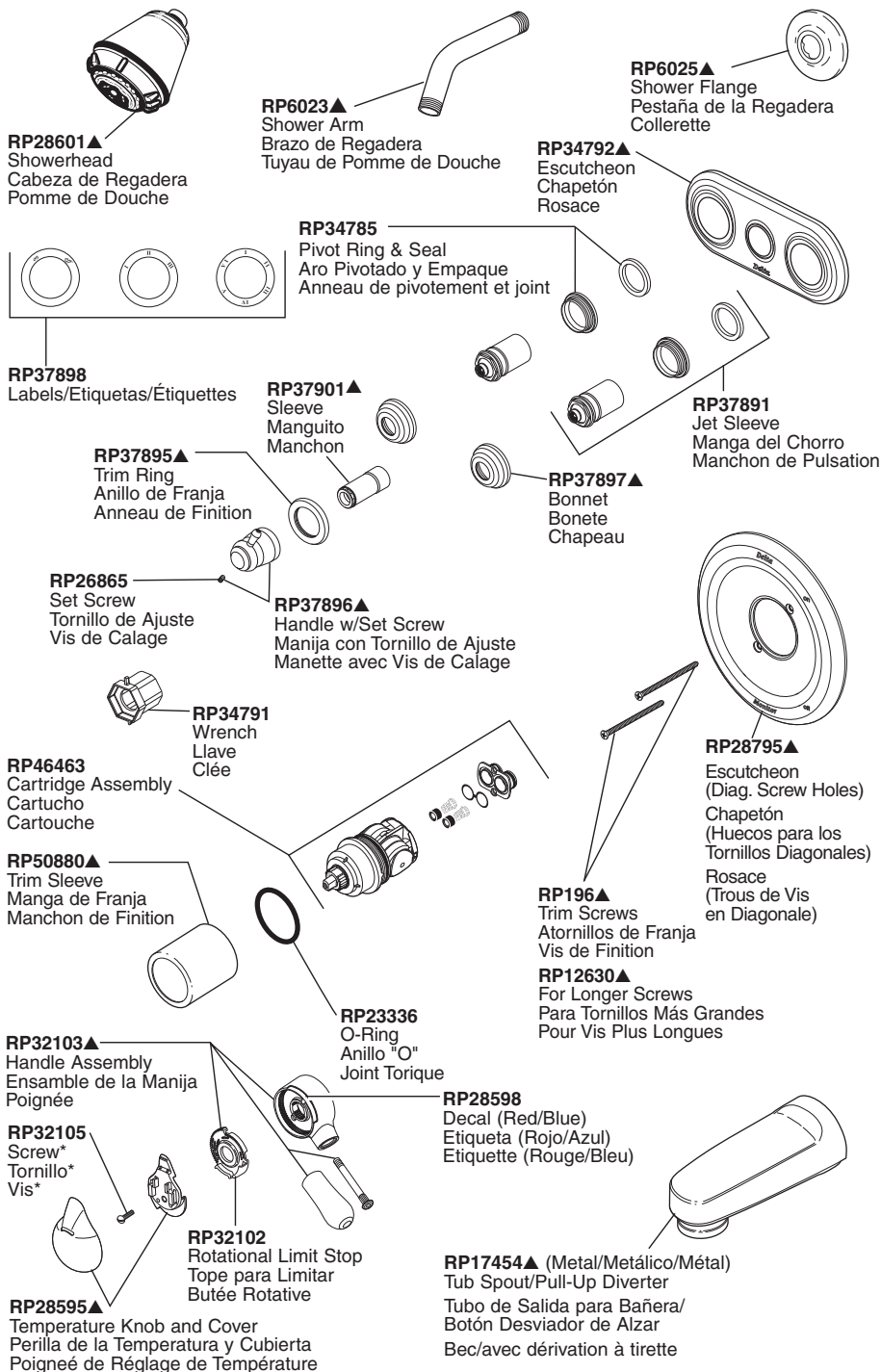

Innovations® Jetted Shower™ Trim Garniture Jetted Shower™ Innovations®

Adorno Innovations® para Jetted Shower™

Innovations® Jetted Shower™

Models/Modelos/Modèles T18T230 Series/Series/Seria

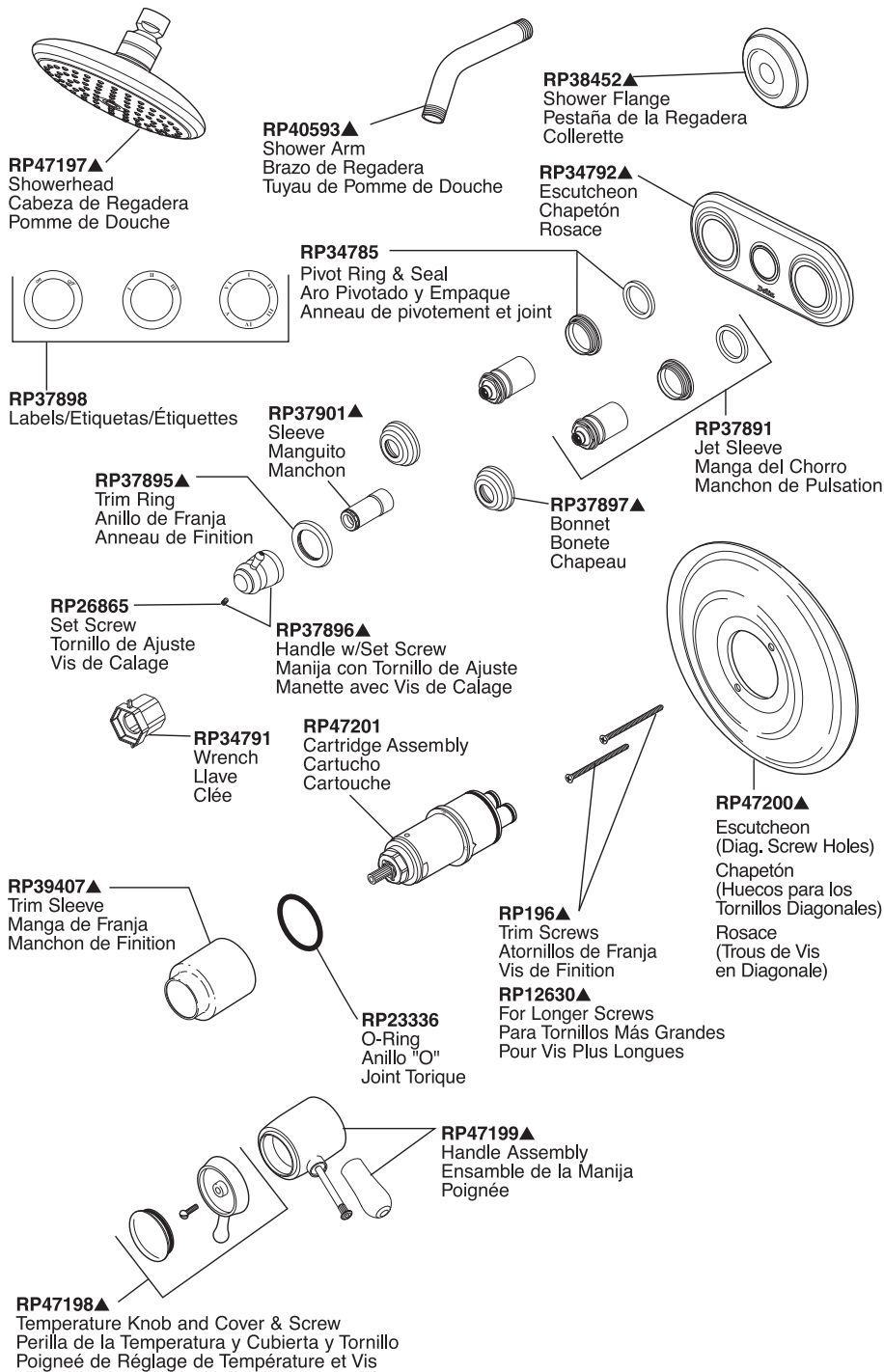

Innovations® Roman Tub Trim Garniture de Bain Romain Innovations®

Adorno Innovations® para Bañera Romana

Innovations® Roman Tub

Models/Modelos/Modèles T2730 & T2783 Series/Series/Seria

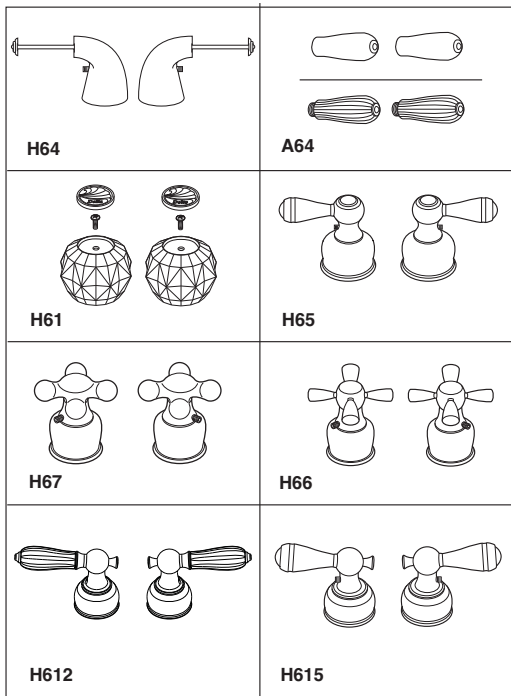
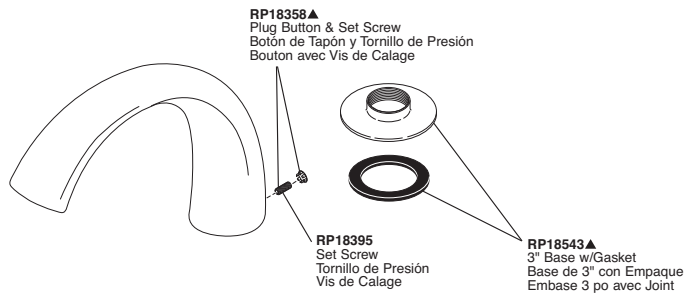
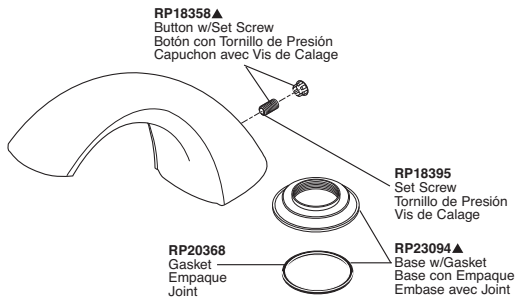

▲Specify Finish/Especifique el Acabado/Précisez le Fini

Contact your distributor for handle and accent options/finishes.

Comuníquese con su distribuidor para obtener opciones en el tipo de manija y detalles (acentos)/acabados.

Pour obtenir des renseignements sur les poignées, les garnitures et les finis livrables, veuillez communiquer avec votre distributeur.

Lahara® Tub/Shower Trim Garniture pour Bain/Douche Lahara®

Adorno Lahara® para Bañera/Ducha

Lahara® Tub/Shower

Models/Modelos/Modèles T14038, T14238, T14238-H2O, T14438 & T14438-H2O Series/Series/Seria



RP54752▲
Showerhead
Cabeza de Rogadora
Pomme de Douche



RP41589▲
Showerhead
Cabeza de Rogadora
Pomme de Douche



RP6023▲
Shower Arm
Brazo de la Rogadora
Tuyau de Pomme de Douche



RP6025▲
Shower Flange
Pestaña de la Rogadora
Collerette

RP19809▲
Escutcheon
Roseta
Rosace avec Orifice

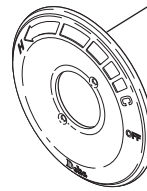

RP196▲
Trim Screws/Atornillos de Franja/
Vis de Finition

RP12630▲
For Longer Screws
Para Tornillos Más Grandes
Pour Vis Plus Longues

***RP46074**
Valve Cartridge
Válvula de Cartucho
Cartouche

RP23336
O-Ring
Anillo "O"
Joint Torique

RP29569
Spacer
Separadores
Pièce D'espacement

RP14414
O-Rings
Anillos "O"
Joints Toriques

RP4993
Seats & Springs
Asientos y Resorts
Sièges et Ressorts



RP25620
Set Screw
Tornillo de Ajuste
Vis de Calage



RP50879▲
Trim Sleeve
Manga de Franja
Manchon de Finition

RP51304▲
Handle Assembly
Ensamble de la Manija
Poignée

RP26853
Wrench/Llave/Clé

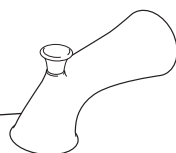

RP51303▲
Tub Spout/Pull-Up Diverter
Tubo de Salida para Bañera/
Botón Desviador de Alzar
Bec/avec dérivation à tirette

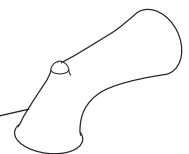

RP53237▲
Tub Spout/Non Diverter
Tubo de Salida para Bañera/Sin Desviador
Bec/Sans Dérivation

In2ition® Showerhead Pomme de Douche d'In2ition®

Cabeza de la Regadera de In2ition®

Model/Modelo/Modèle 144938-I Series/Series/Seria

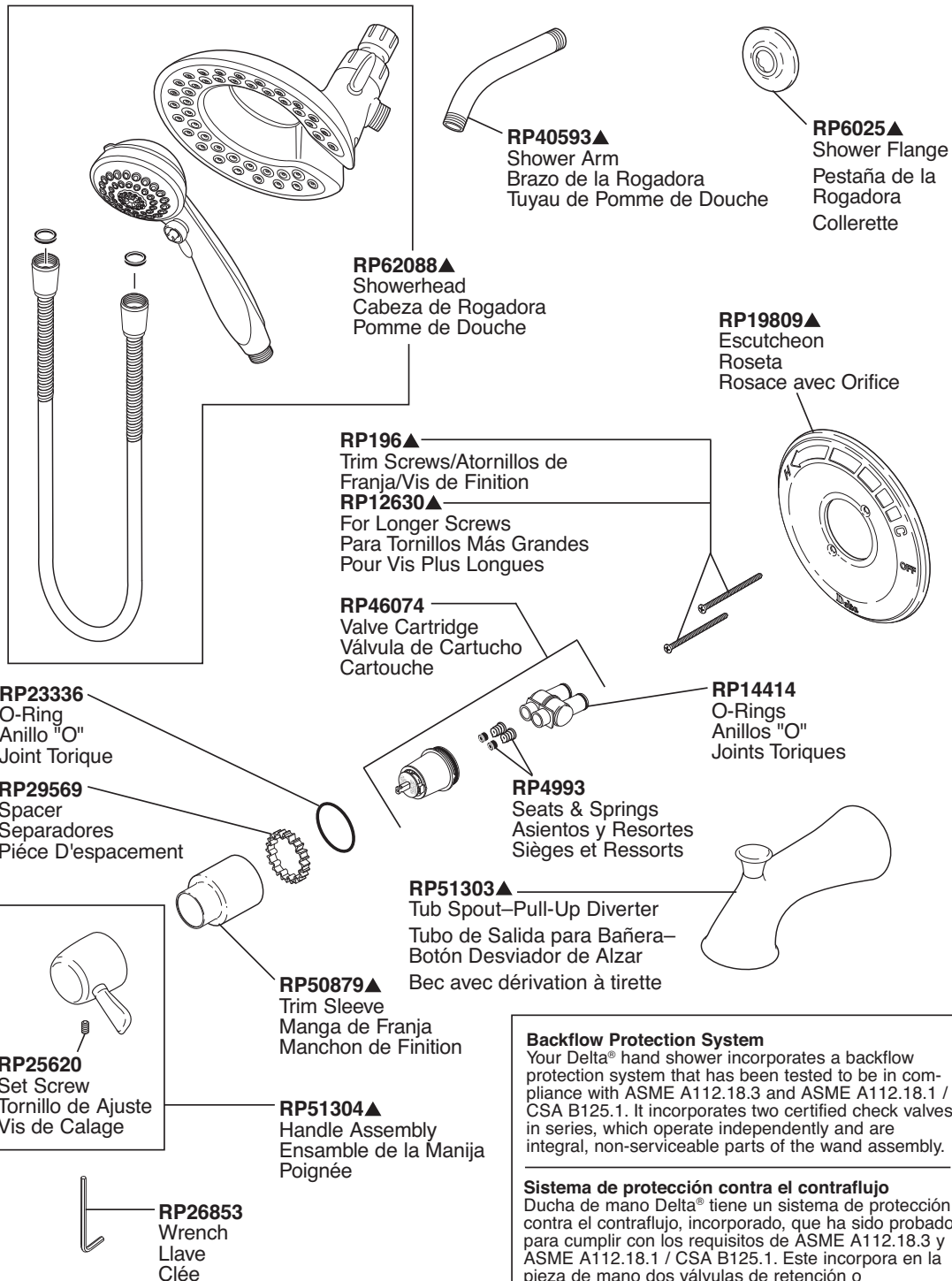

Backflow Protection System

Your Delta® hand shower incorporates a backflow protection system that has been tested to be in compliance with ASME A112.18.3 and ASME A112.18.1 / CSA B125.1. It incorporates two certified check valves in series, which operate independently and are integral, non-serviceable parts of the wand assembly.

Sistema de protección contra el contraflujo

Ducha de mano Delta® tiene un sistema de protección contra el contraflujo, incorporado, que ha sido probado para cumplir con los requisitos de ASME A112.18.3 y ASME A112.18.1 / CSA B125.1. Este incorpora en la pieza de mano dos válvulas de retención o checadoras certificadas en una serie, las cuales operan independientemente y son piezas integrantes que no requieren servicio.

Dispositif anti-siphonnage

Douche à main Delta® comporte un dispositif anti-siphonnage qui a été éprouvé et qui est conforme aux normes ASME A112.18.3 et ASME A112.18.1 / CSA B125.1. Ce dispositif se compose de deux clapets indépendants homologués, montés en série dans le tube rigide, qui sont non réparables.

Tub/Shower Trim

Garniture pour Bain/Douche

Adorno para Bañera/Ducha

Models/Modelos/Modèles T17038, T17138, T17238, T17438,
T17238-H2O & T17438-H2O Series/Series/Seria



RP70173▲
Showerhead
Cabeza de Rogadora
Pomme de Douche

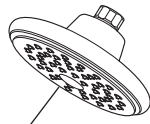

RP51305▲
Showerhead
Cabeza de Rogadora
Pomme de Douche



RP46384▲
Showerhead
Cabeza de Rogadora
Pomme de Douche



RP6023▲
Shower Arm
Brazo de la Rogadora
Tuyau de Pomme de Douche



RP6025▲
Shower Flange
Pestaña de la Rogadora
Collerette

RP32105
Screw/Tornillo/Vis

NOTE: Do NOT overtighten screw
NOTA: NO apriete demasiado el tornillo
NOTE: NE serrez PAS trop la vis

RP196▲
Trim Screws
Atornillos de Franja
Vis de Finition

RP12630▲
For Longer Screws
Para Tornillos Más Grandes
Pour Vis Plus Longues

*** RP46463**
Cartridge Assembly
Cartucho
Cartouche

RP50880▲
Trim Sleeve
Manga de Franja
Manchon de Finition

RP32102
Rotational Limit Stop
Tope para Limitar
Butée Rotative

RP23336
O-Ring
Anillo "O"
Joint Torique

RP28795▲
Escutcheon
Roseta
Rosace avec Orifice

RP51306▲
Handle Assembly
Ensamble de la Manija
Poignée

RP51307▲
Temperature Knob and Cover
Perilla de la Temperatura y Cubierta
Poigné de Réglage de Température

RP51303▲
Tub Spout/Pull-Up Diverter
Tubo de Salida para Bañera/
Botón Desviador de Alzar
Bec/avec dérivation à tirette

Tub/Shower Trim Garniture pour Bain/Douche

Adorno para Bañera/Ducha

Models/Modelos/Modèles T17T038, T17T238 & T17T438 Series/Series/Seria

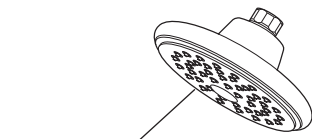

RP51305▲
Showerhead
Cabeza de Regadera
Pomme de Douche



RP40593▲
Shower Arm
Brazo de Regadera
Tuyau de Pomme de Douche



RP6025▲
Shower Flange
Pestaña de la Regadera
Collerette

RP48307▲
Escutcheon (Diagonal Screw Holes)
Chapetón (Huecos para los Tornillos Diagonales)
Rosace (Trous de Vis en Diagonale)

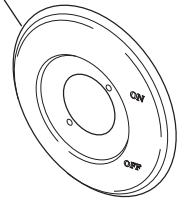

RP196▲
Trim Screws
Atornillos de Franja
Vis de Finition

RP12630▲
For Longer Screws
Para Tornillos Más Grandes
Pour Vis Plus Longues

RP50879▲
Trim Sleeve
Manga de Franja
Manchon de Finition



RP51308▲
Handle Assembly
Ensamble de la Manija
Poignée

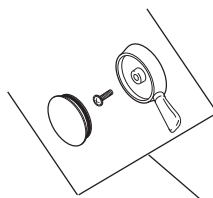

RP47201*
Cartridge Assembly
Cartucho
Cartouche

RP23336
O-Ring
Anillo "O"
Joint Torique



RP50465
Set Screw & Wrench
Tornillo de Ajuste y Llave
Vis de calage et Clé

RP51309▲
Temperature Knob, Cover & Screw
Perilla de la Temperatura, Cubierta y Tornillo
Poignée de Réglage de Température et Vis

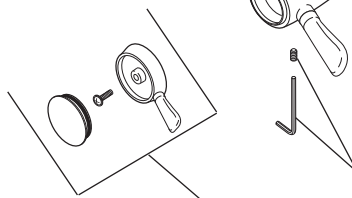

RP51303▲
Tub Spout/Pull-Up Diverter
Tubo de Salida para Bañera/
Botón Desviador de Alzar
Bec/avec dérivation à tirette

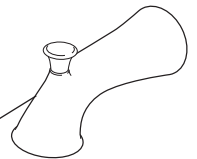

Lahara® Roman Tub Trim Garniture de Bain Romain Lahara®

Adorno Lahara® para Bañera Romana

Lahara® Roman Tub

Model/Modelo/Modèle T2738 & T4738 Series/Series/Seria

T2738

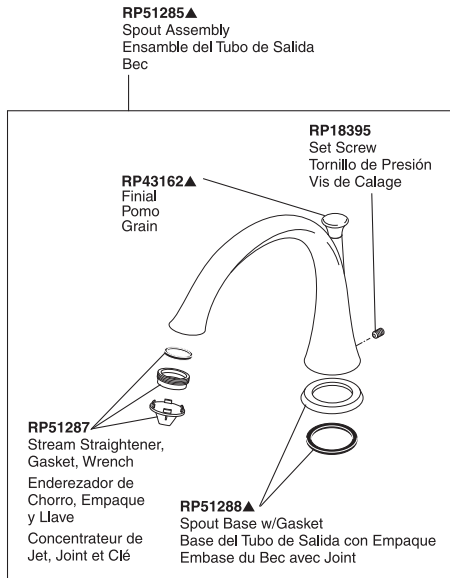

RP51289▲
Handle and
Glide Ring
Manija y
Aro para Deslizar
Manette et
L'anneau de Glissement



RP51628▲
Handle Base w/Gasket
Base de la Manija con Empaque
Embase de manette avec Joint

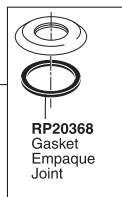

T4738

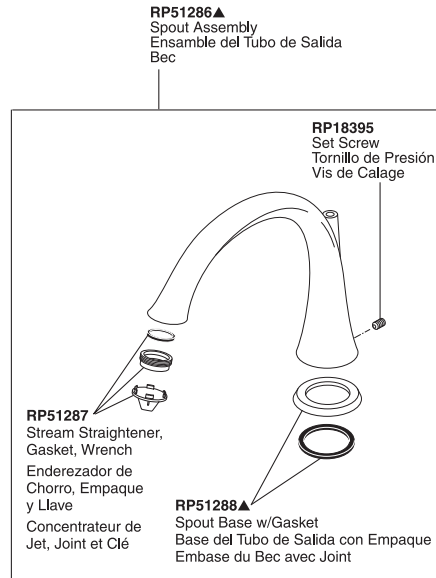

RP46680▲
Hand Piece
Pieza de Mano
Douche à main

RP51290▲
Hand Piece Base
Base para la Pieza de mano
Base de la douche à main

RP40663▲
Conical Nut
Tuerca Cónica
Ecrrou conique

RP40664
Hose and Gaskets
Manguera y Empaques
Tuyau souple et joints

RP51628▲
Handle Base w/Gasket
Base de la Manija con Empaque
Embase de manette avec Joint

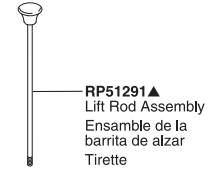

RP51289▲
Handle and
Glide Ring
Manija y
Aro para Deslizar
Manette et
L'anneau de Glissement

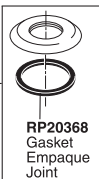

Leland® Tub/Shower Trim

Garniture pour Bain/Douche Leland®

Adorno Leland® para Bañera/Ducha

Leland® Tub/Shower

Models/Modelos/Modèles T14078, T14178, T14278 & T14478 Series/Series/Seria

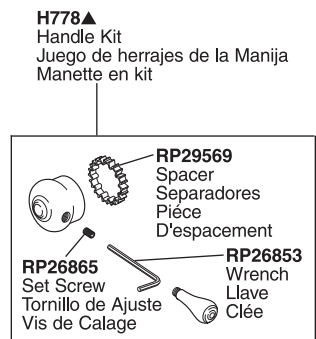
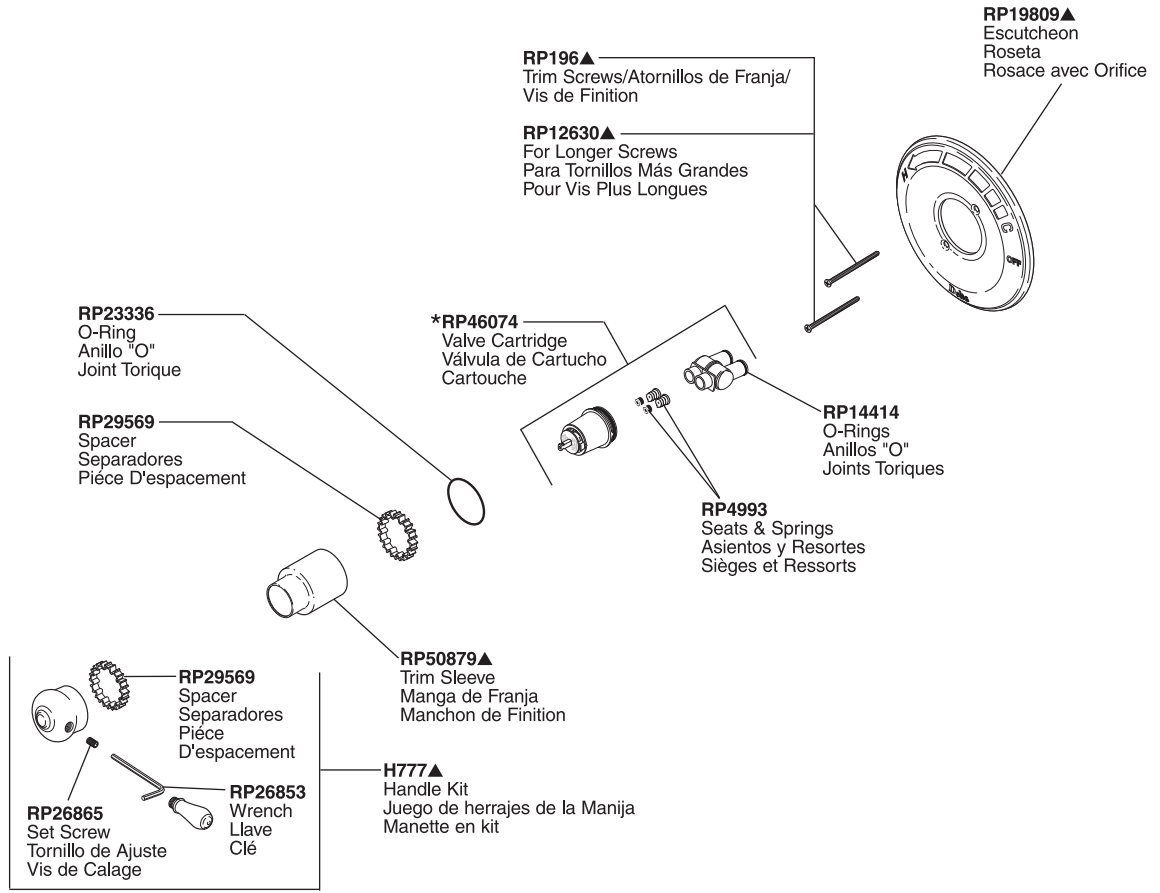
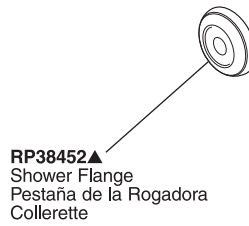
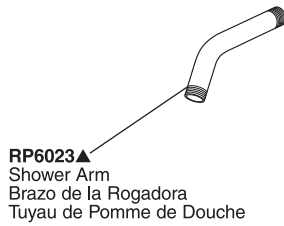

Leland® Tub/Shower Trim

Garniture pour Bain/Douche Leland®

Adorno Leland® para Bañera/Ducha

Leland® Tub/Shower

Models/Modelos/Modèles T14278-H2O & T14478-H2O Series/Series/Seria

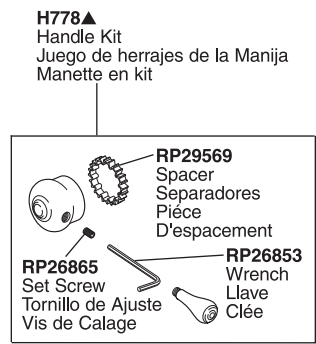
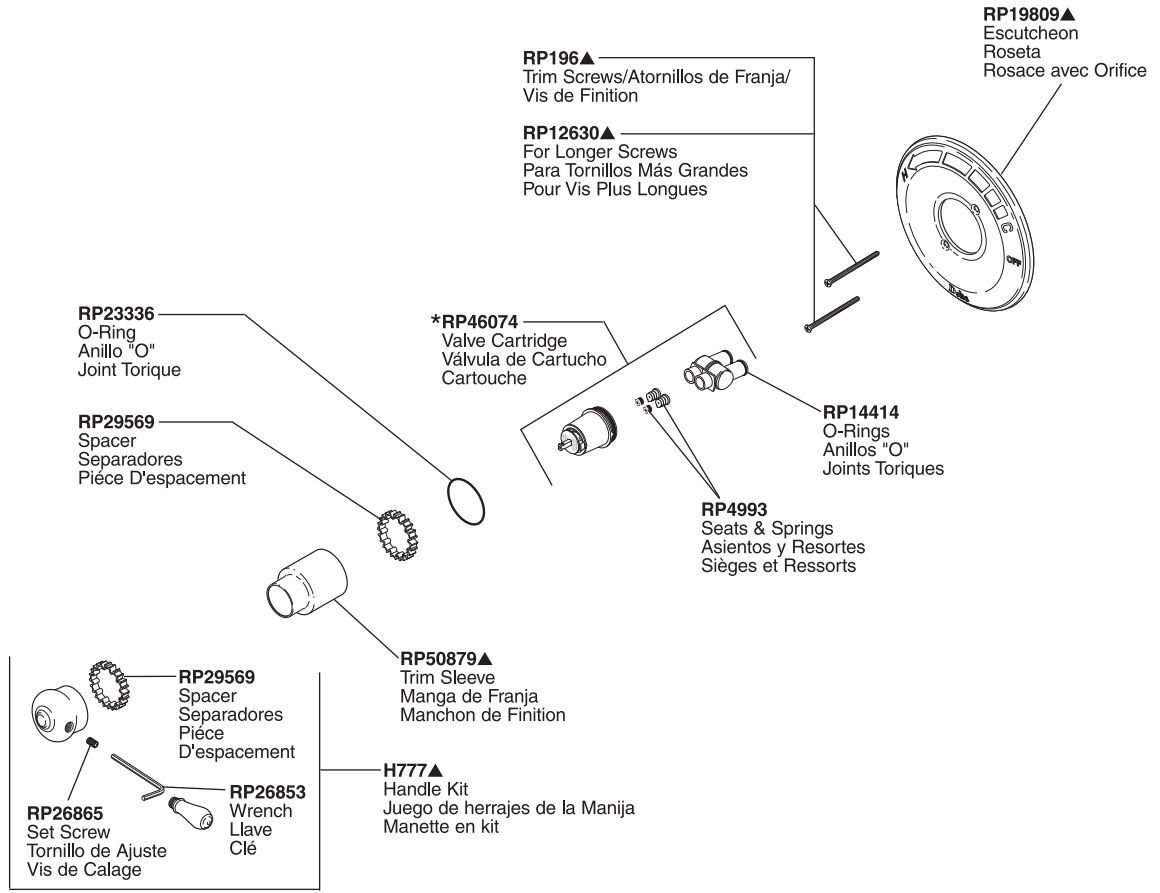
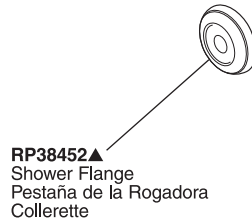
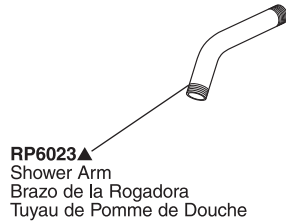
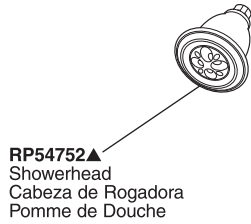

Tub/Shower Trim Garniture pour Bain/Douche

Adorno para Bañera/Ducha

Models/Modelos/Modèles T17078, T17178, T17278, T17478,
T17278-H2O & T17478-H2O Series/Series/Seria

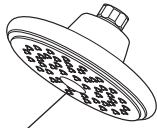

RP51305▲
Showerhead
Cabeza de Rogadora
Pomme de Douche

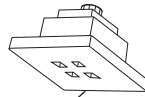

RP51032▲
Showerhead
Cabeza de Rogadora
Pomme de Douche



RP6023▲
Shower Arm
Brazo de la Rogadora
Tuyau de Pomme de Douche



RP6025▲
Shower Flange
Pestaña de la Rogadora
Collerette



RP70172▲
Showerhead
Cabeza de Rogadora
Pomme de Douche

RP196▲
Trim Screws
Atornillos de Franja
Vis de Finition

RP12630▲
For Longer Screws
Para Tornillos Más Grandes
Pour Vis Plus Longues

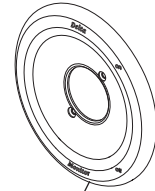

RP28795▲
Escutcheon
Roseta
Rosace avec Orifice

RP32105
Screw/Tornillo/Vis

NOTE: Do NOT overtighten screw
NOTA: NO apriete demasiado el tornillo
NOTE: NE serrez PAS trop la vis

***RP46463**
Cartridge Assembly
Cartucho
Cartouche

RP50880▲
Trim Sleeve
Manga de Franja
Manchon de Finition

RP28598
Decal (Red/Blue)
Etiqueta (Rojo/Azul)
Étiquette (Rouge/Bleu)

RP32102
Rotational Limit Stop
Tope para Limitar
Butée Rotative

RP23336
O-Ring
Anillo "O"
Joint Torique

RP51425▲
Handle Assembly
Ensamble de la Manija
Poignée

RP51424▲
Temperature Knob and Cover
Perilla de la Temperatura y Cubierta
Poignéé de Réglage de Température

RP42915▲
Tub Spout/Pull-Up Diverter
Tubo de Salida para Bañera/
Botón Desviador de Alzar
Bec/avec dérivation à tirette

Tub/Shower Trim Garniture pour Bain/Douche

Adorno para Bañera/Ducha

Models/Modelos/Modèles T17T078, T17T278 & T17T478 Series/Series/Seria

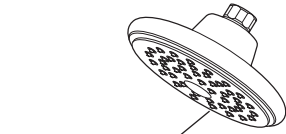

RP51305▲
Showerhead
Cabeza de Regadera
Pomme de Douche



RP6023▲
Shower Arm
Brazo de Regadera
Tuyau de Pomme de Douche



RP6025▲
Shower Flange
Pestaña de la Regadera
Collerette

RP48307▲
Escutcheon
(Diagonal Screw Holes)
Chapetón
(Huecos para los Tornillos Diagonales)
Rosace
(Trous de Vis en Diagonale)

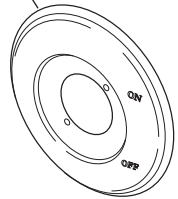

RP50879▲
Trim Sleeve
Manga de Franja
Manchon de Finition

RP51427▲
Handle Assembly
Ensamble de la Manija
Poignée

RP50465
Set Screw & Wrench
Tornillo de Ajuste y Llave
Vis de calage et Clé

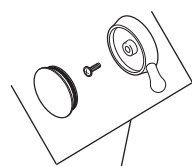

RP51426▲
Temperature Knob, Cover & Screw
Perilla de la Temperatura, Cubierta y Tornillo
Poignée de Réglage de Température et Vis

RP47201*
Cartridge Assembly
Cartucho
Cartouche

RP23336
O-Ring
Anillo "O"
Joint Torique

RP196▲
Trim Screws
Atornillos de Franja
Vis de Finition

RP12630▲
For Longer Screws
Para Tornillos Más Grandes
Pour Vis Plus Longues

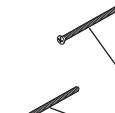

RP42915▲
Tub Spout/Pull-Up Diverter
Tubo de Salida para Bañera/
Botón Desviador de Alzar
Bec/avec dérivation à tirette

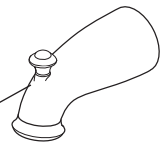

Leland® Roman Tub & Garden Tub Trim Garniture Bain Extérieur et Bain Romain Leland®

Adorno Leland® para Bañera Romana y Bañera de Jardín

Leland® Roman Tub

Models/Modelos/Modèles T2778 & T5778 Series/Series/Seria

RP41884▲ (5778)
RP41584▲ (2778)
Spout Assembly
Ensamble del Tubo de Salida
Bec

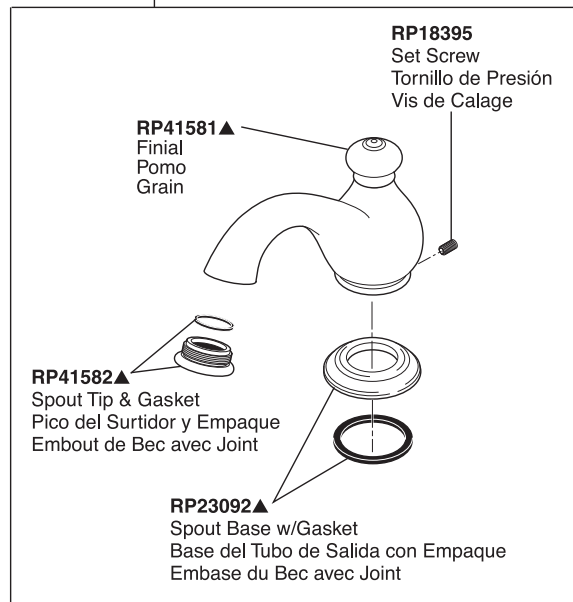

RP23094▲
Handle Base w/Gasket
Base de la Manija con Empaque
Embase de manette avec Joint

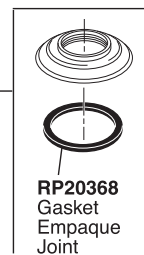

Leland® Roman Tub Trim Garniture de Bain Romain Leland®

Adorno Leland® para Bañera Romana

Leland® Roman Tub

Model/Models/Modèle T4778 Series/Series/Seria

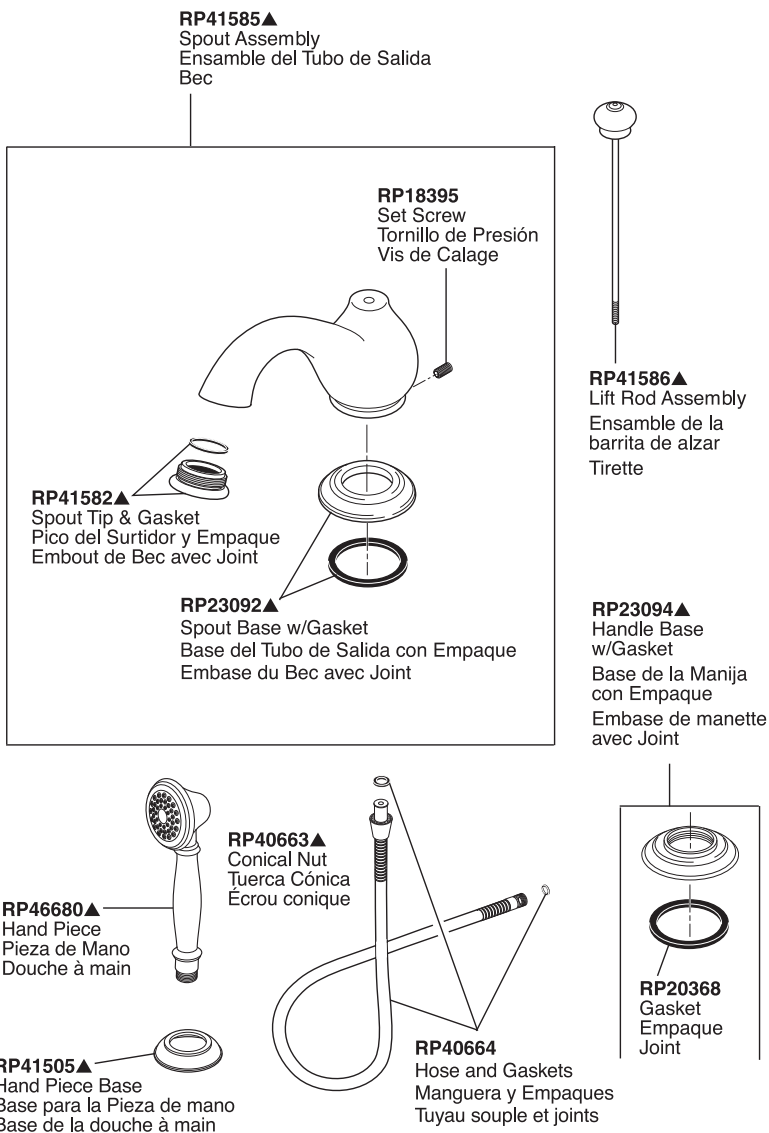

Leland® Roman Tub Trim Garniture de Bain Romain Leland®

Adorno Leland® para Bañera Romana

Leland® Roman Tub

Models/Modelos/Modèles T2775 & T4775 Series/Series/Seria

Model / Modelo / Modèle T2775

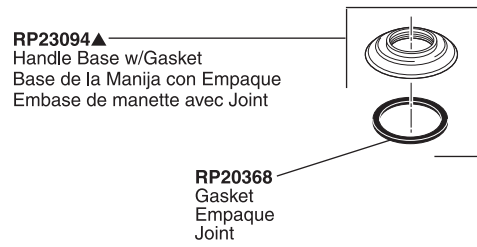
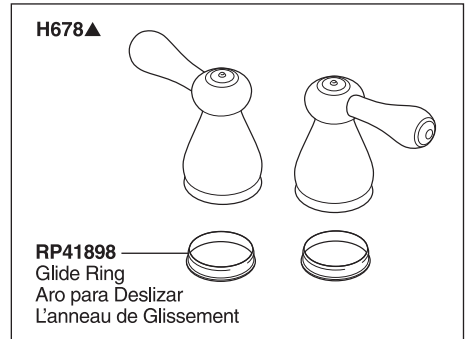
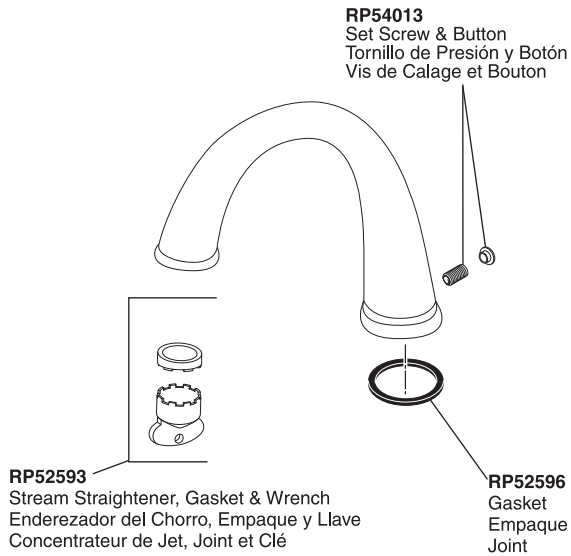

Model / Modelo / Modèle T4775

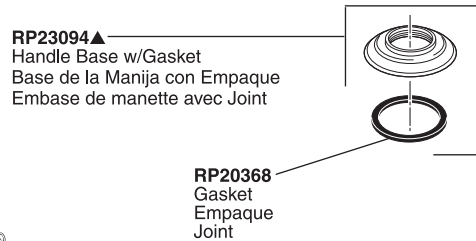
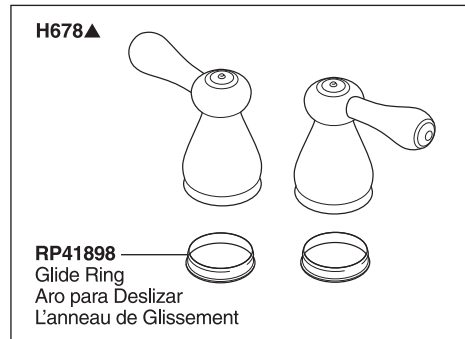
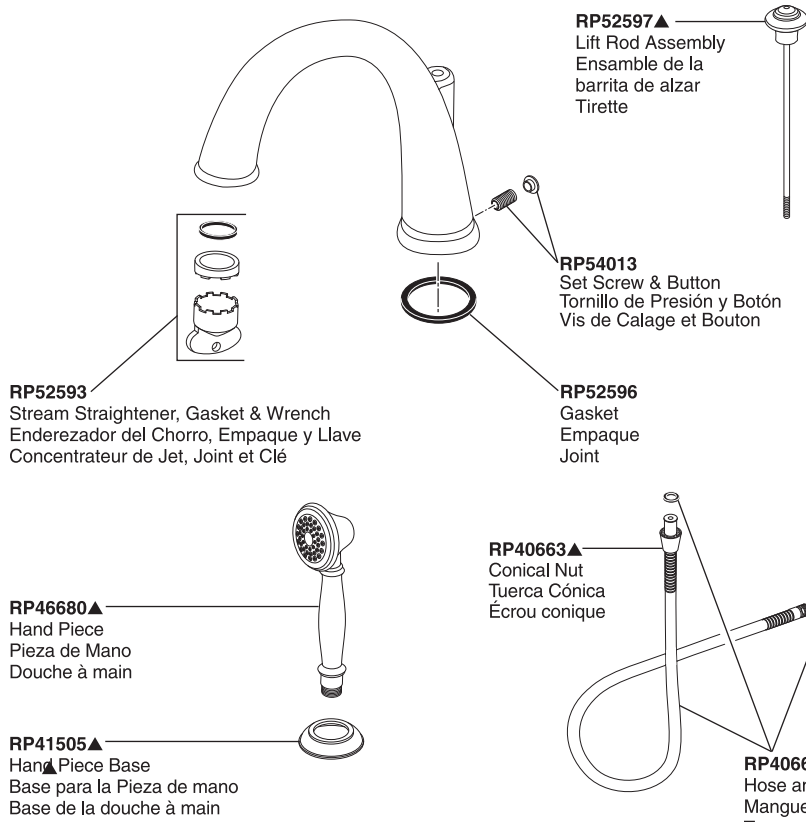

Linden® Tub/Shower Trim Garniture pour Bain/Douche Linden®

Adorno Linden® para Bañera/Ducha

Linden® Tub/Shower

Models/Modelos/Modèles T14094, T14194, T14294, T14294-H2O,
T14494 & T14494-H2O Series/Series/Seria



RP54752▲
Showerhead
Cabeza de Rogadora
Pomme de Douche

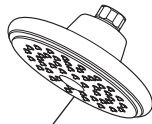

RP51305▲
Showerhead
Cabeza de Rogadora
Pomme de Douche

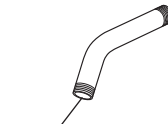

RP6023▲
Shower Arm
Brazo de la Rogadora
Tuyau de Pomme de Douche



RP6025▲
Shower Flange
Pestaña de la Rogadora
Collerette

RP196▲
Trim Screws/Atornillos de Franja/
Vis de Finition

RP12630▲
For Longer Screws
Para Tornillos Más Grandes
Pour Vis Plus Longues

RP34353▲
Escutcheon
Roseta
Rosace avec Orifice

RP23336
O-Ring
Anillo "O"
Joint Torique

RP29569
Spacer
Separadores
Pièce D'espacement

***RP46074**
Valve Cartridge
Válvula de Cartucho
Cartouche

RP14414
O-Rings
Anillos "O"
Joints Toriques

RP4993
Seats & Springs
Asientos y Resortes
Sièges et Ressorts

RP50879▲
Trim Sleeve
Manga de Franja
Manchon de Finition

RP25620
Set Screw
Tornillo de Ajuste
Vis de Calage

RP70639▲
Handle Assembly
Ensamble de la Manija
Poignée

RP26853
Wrench
Llave
Clé

RP52153▲
Tub Spout/Pull-Up Diverter
Tubo de Salida para Bañera/
Botón Desviador de Alzar
Bec/avec dérivation à tirette

Tub/Shower Trim Garniture pour Bain/Douche

Adorno para Bañera/Ducha

Models/Modelos/Modèles T17094, T17294, T17494, T17294-I & T17494-I Series/Series/Seria



RP70173▲
Showerhead
Cabeza de Rogadora
Pomme de Douche

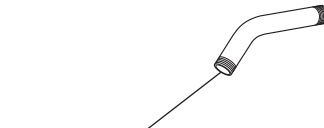

RP6023▲
Shower Arm
Brazo de la Rogadora
Tuyau de Pomme de Douche

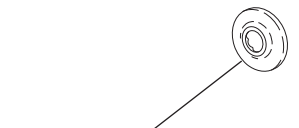

RP6025▲
Shower Flange
Pestaña de la Rogadora
Collerette

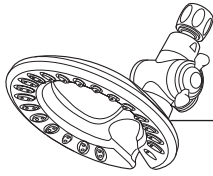

RP64024▲
Showerhead
Cabeza de Rogadora
Pomme de Douche

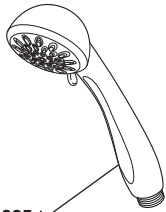

RP64025▲
Handshower
Regadera Manual
Douche à main

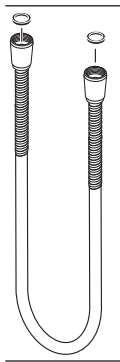

RP64021
Hose & Gaskets
Manguera y Empaques
Tuyau souple et joints

RP196▲
Trim Screws
Atornillos de Franja
Vis de Finition

RP12630▲
For Longer Screws
Para Tornillos Más Grandes
Pour Vis Plus Longues

***RP46463**
Cartridge Assembly
Cartucho
Cartouche

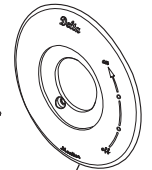

RP34354▲
Escutcheon
Roseta
Rosace avec Orifice

RP32105
Screw/Tornillo/Vis

NOTE: Do NOT overtighten screw
NOTA: NO apriete demasiado el tornillo
NOTE: NE serrez PAS trop la vis

RP28598
Decal (Red/Blue)
Etiqueta (Rojo/Azul)
Etiquette (Rouge/Bleu)

RP50880▲
Trim Sleeve
Manga de Franja
Manchon de Finition

RP23336
O-Ring
Anillo "O"
Joint Torique

RP32102
Rotational Limit Stop
Tope para Limitar
Butée Rotative

RP70640▲
Handle Assembly
Ensamble de la Manija
Poignée

RP70641▲
Temperature Knob and Cover
Perilla de la Temperatura y Cubierta
Poignée de Réglage de Température

RP52153▲
Tub Spout/Pull-Up Diverter
Tubo de Salida para Bañera/
Botón Desviador de Alzar
Bec/avec dérivation à tirette

Linden™ Roman Tub Trim Garniture de Bain Romain Linden™

Adorno Linden™ para Bañera Romana

Linden™ Roman Tub

Models/Modelos/Modèles T2794 & T4794 Series/Series/Seria

Model / Modelo / Modèle T2794

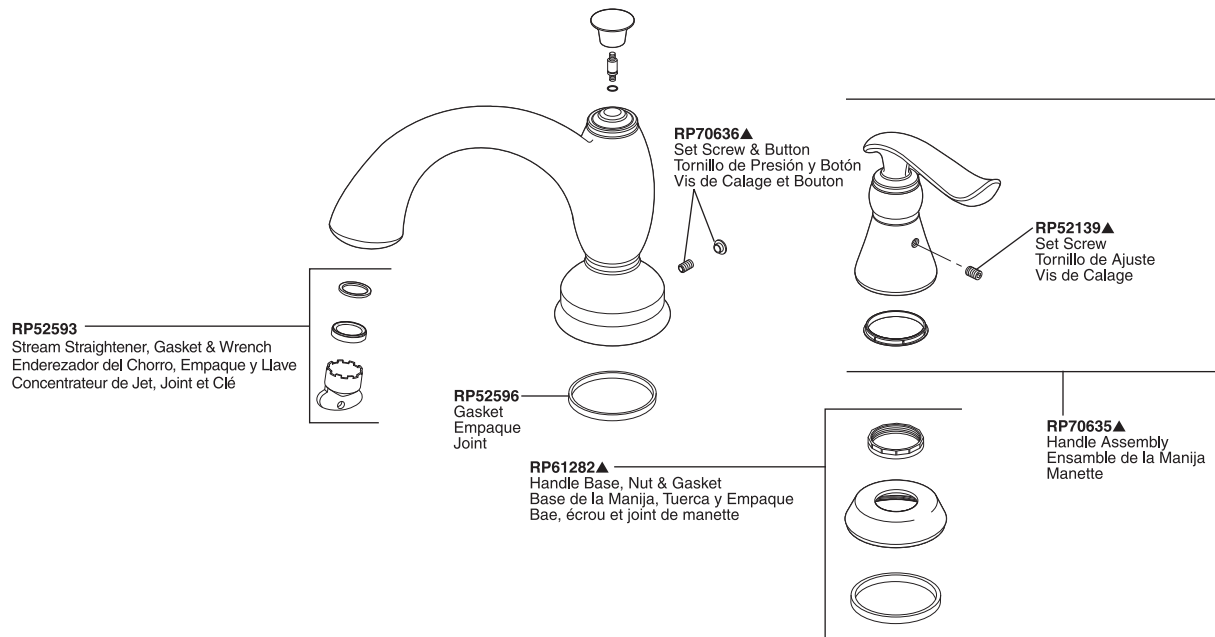

Model / Modelo / Modèle T4794

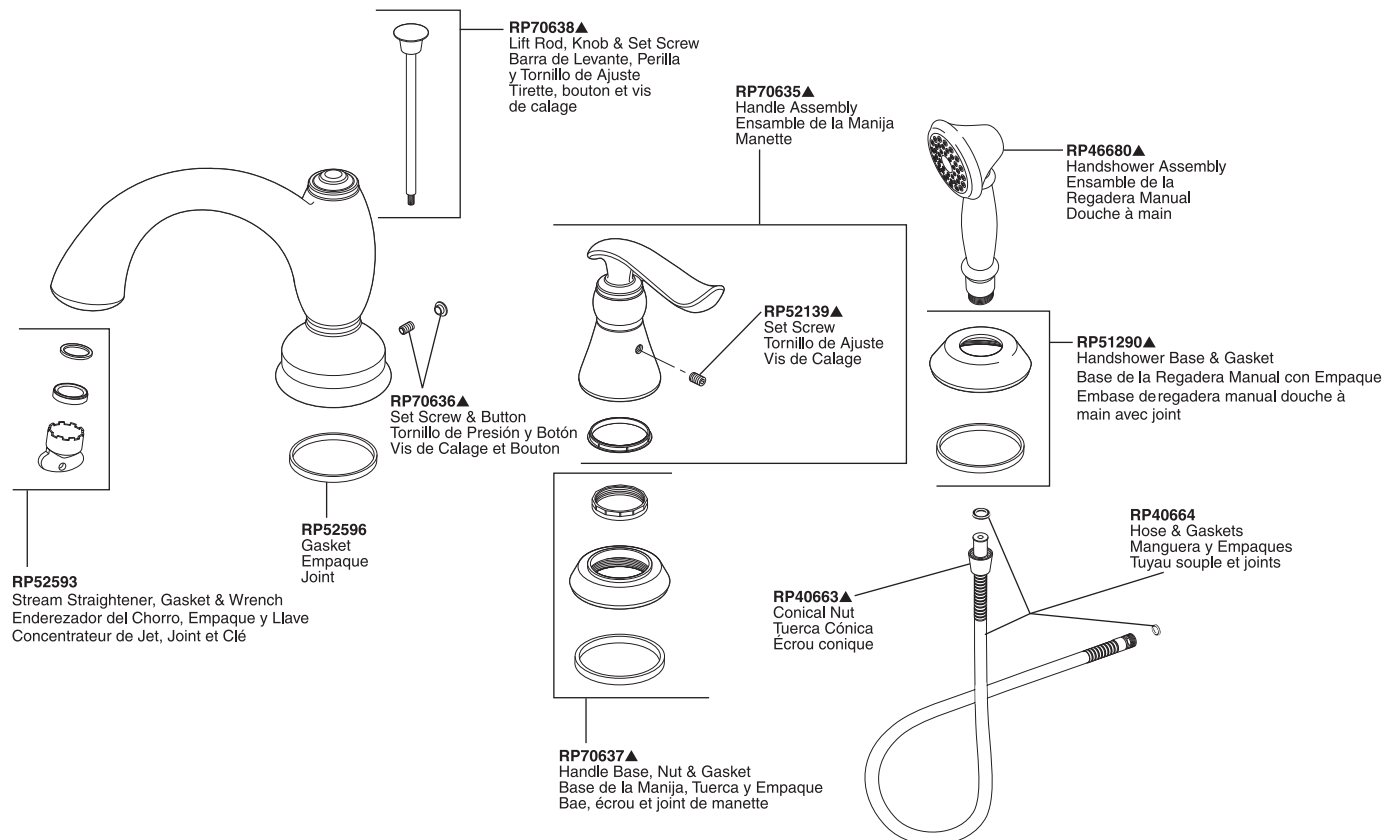

▲ Specify finish / Especificque el Acabado / Précisez le fini

Tub/Shower Trim Garniture pour Bain/Douche

Adorno para Bañera/Ducha

Model/Modelo/Modèle 144962 Series/Series/Seria

Linden® Tub/Shower

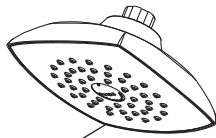

RP64859▲
Showerhead
Cabeza de Rogadora
Pomme de Douche

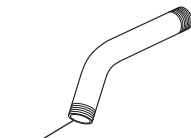

RP6023▲
Shower Arm
Brazo de la Rogadora
Tuyau de Pomme de Douche



RP6025▲
Shower Flange
Pestaña de la Rogadora
Collerette

RP64860▲
Escutcheon
Roseta
Rosace avec Orifice

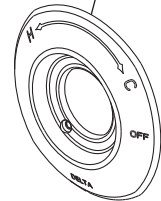

RP196▲
Trim Screws/Atornillos de
Franja/Vis de Finition
RP12630▲
For Longer Screws
Para Tornillos Más Grandes
Pour Vis Plus Longues

RP46074
Valve Cartridge
Válvula de Cartucho
Cartouche

RP14414
O-Rings
Anillos "O"
Joints Toriques

RP23336
O-Ring
Anillo "O"
Joint Torique

RP29569
Spacer
Separadores
Pièce D'espacement

RP4993
Seats & Springs
Asientos y Resortes
Sièges et Ressorts

RP46071
Housing Assembly
Ensamble de Caja
Boitier

RP46070
Cap Assembly
Ensamble de Tapón
Soupape

RP39407▲
Trim Sleeve & Spacer
Manga de Franja y Separadores
Manchon de Finition et Pièce D'espacement

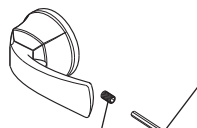

RP26853
Wrench
Llave
Clée

RP25620
Set Screw
Tornillo de Ajuste
Vis de Calage

RP64861▲
Handle Kit
Juego de herrajes de la Manija
Manette en kit

RP64862▲
Tub Spout/Pull-Up Diverter
Tubo de Salida para Bañera/
Botón Desviador de Alzar
Bec/avec dérivation à tirette

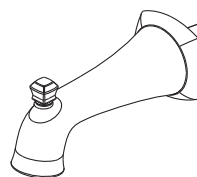

Tub/Shower Valves Garniture pour Bain/Douche

Adorno para Bañera/Ducha

Models/Modelos/Modèles 144710 & 142710 Series/Series/Seria

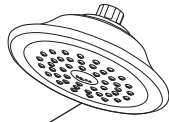

RP71020▲
Showerhead
Cabeza de Rogadora
Pomme de Douche

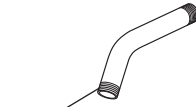

RP6023▲
Shower Arm
Brazo de la Rogadora
Tuyau de Pomme de Douche



RP6025▲
Shower Flange
Pestaña de la Rogadora
Collerette

RP71021▲
Escutcheon
Roseta
Rosace avec Orifice

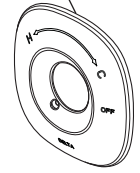

RP196▲
Trim Screws/Atornillos de Franja
Vis de Finition

RP12630▲
For Longer Screws
Para Tornillos Más Grandes
Pour Vis Plus Longues

RP46074
Valve Cartridge
Válvula de Cartucho
Cartouche

RP23336
O-Ring
Anillo "O"
Joint Torique

RP29569
Spacer
Separadores
Pièce D'espacement

RP14414
O-Rings
Anillos "O"
Joints Toriques

RP46071
Housing Assembly
Ensamble de Caja
Boitier

RP4993
Seats & Springs
Asientos y Resortes
Sièges et Ressorts

RP46070
Cap Assembly
Ensamble de Tapón
Soupape

RP39407▲
Trim Sleeve & Spacer
Manga de Franja y Separadores
Manchon de Finition et Pièce D'espacement

RP71024▲
Button

RP6369
Screw

RP71023▲
Handle Kit
Juego de herrajes de la Manija
Manette en kit



RP71022▲
Tub Spout/Pull-Up Diverter
Tubo de Salida para Bañera/
Botón Desviador de Alzar
Bec/avec dérivation à tirette

Tub/Shower Trim Garniture pour Bain/Douche

Adorno para Bañera/Ducha

Porter Tub/Shower

Model/Modelo/Modèle 144984 Series/Series/Seria

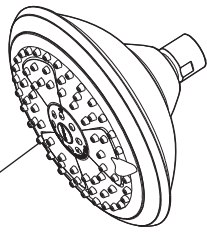

RP62171▲
Showerhead
Cabeza de Regadera
Pomme de douche

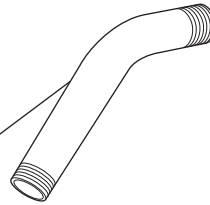

RP6023▲
Shower Arm
Brazo de Regadera
Tuyau de Pomme de Douche



RP6025▲
Shower Flange
Pestaña de la Regadera
Collerette

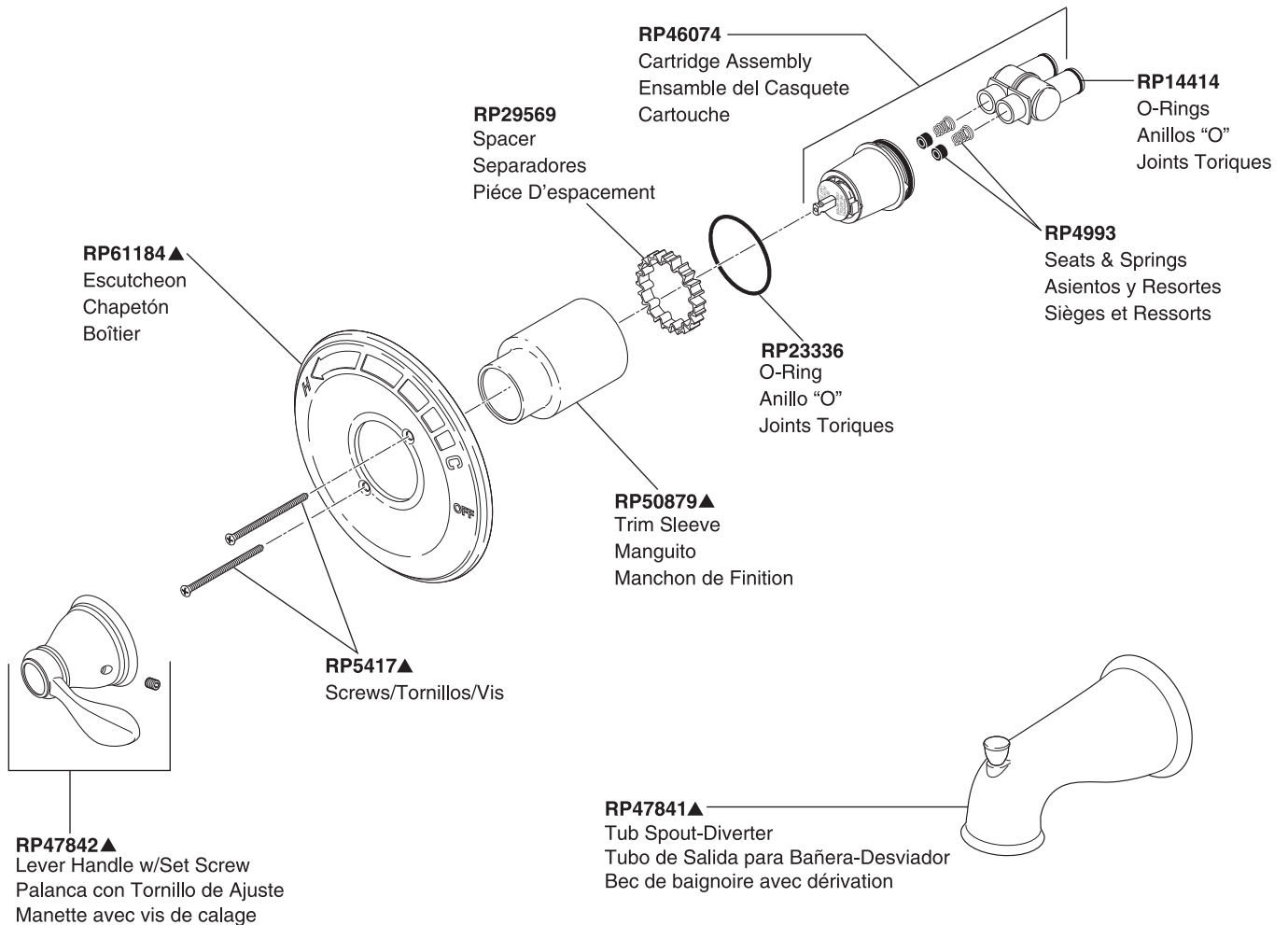

Porter Roman Tub Trim Garniture de Bain Romain Porter

Adorno Porter para Bañera Romana

Porter Roman Tub

Model/Models/Modèle 37984 Series/Series/Seria

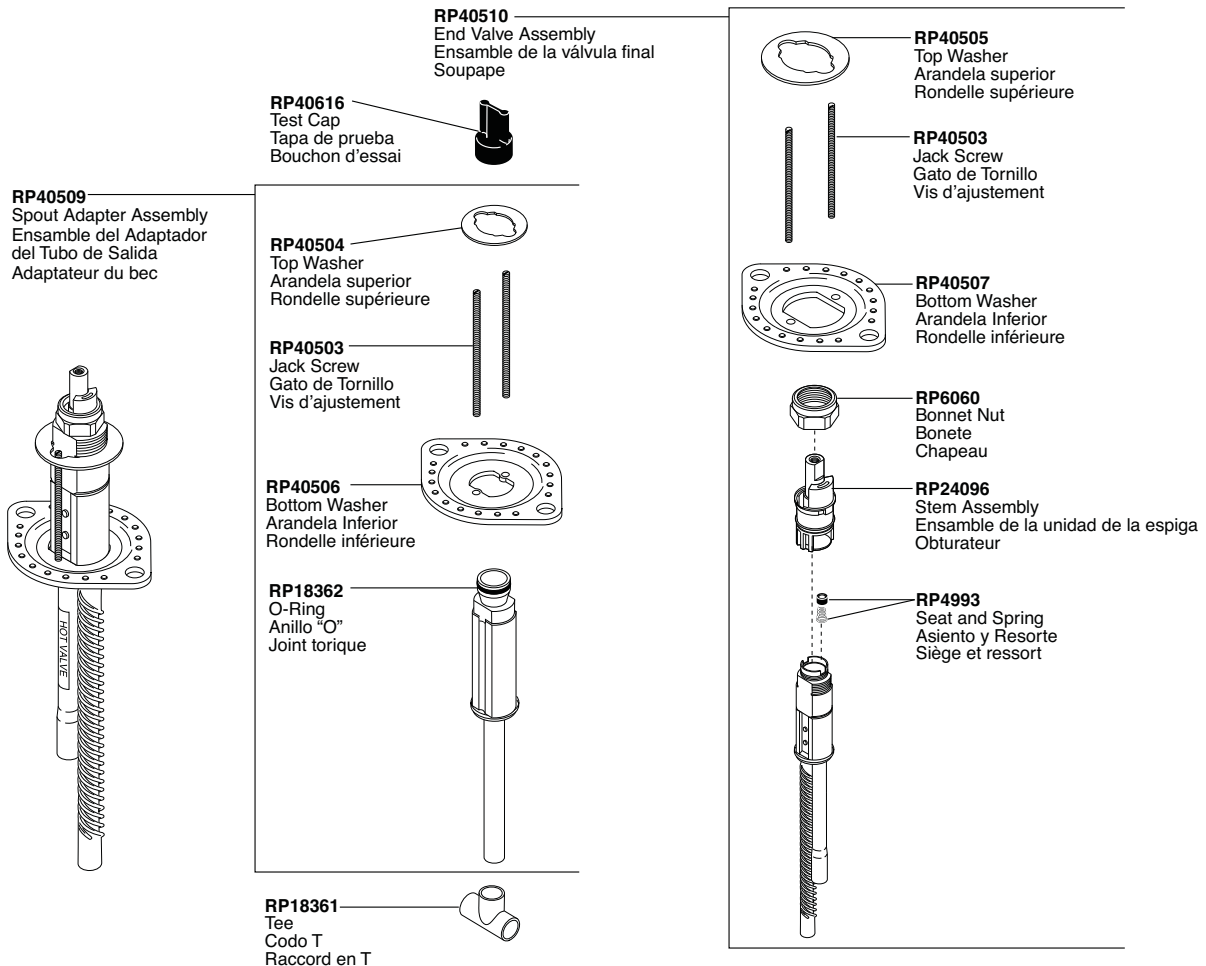
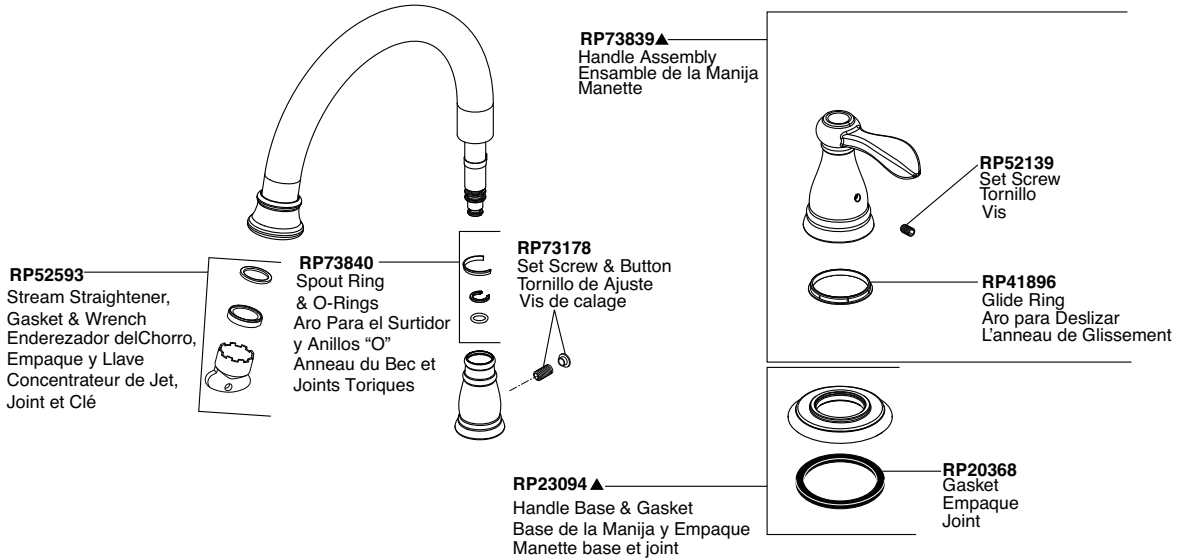

Tub/Shower Trim Garniture pour Bain/Douche

Adorno para Bañera/Ducha

Models/Modelos/Modèles 142960 & 144960 Series/Series/Seria

Talbott Tub/Shower



RP43214▲
Showerhead
Cabeza de Rogadora
Pomme de Douche

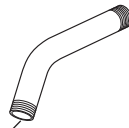

RP6023▲
Shower Arm
Brazo de la Rogadora
Tuyau de Pomme de Douche



RP6025▲
Shower Flange
Pestaña de la Rogadora
Collerette

RP64602▲
Escutcheon
Roseta
Rosace avec Orifice

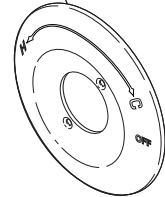

RP196▲
Trim Screws/Atornillos de
Franja/Vis de Finition
RP12630▲
For Longer Screws
Para Tornillos Más Grandes
Pour Vis Plus Longues

RP23336
O-Ring
Anillo "O"
Joint Torique

RP29569
Spacer
Separadores
Pièce D'espacement

RP46074
Valve Cartridge
Válvula de Cartucho
Cartouche

RP14414
O-Rings
Anillos "O"
Joints Toriques

RP4993
Seats & Springs
Asientos y Resortes
Sièges et Ressorts

RP46071
Housing Assembly
Ensamble de Caja
Boitier

RP46070
Cap Assembly
Ensamble de Tapón
Soupape

RP39407▲
Trim Sleeve & Spacer
Manga de Franja y Separadores
Manchon de Finition et Pièce D'espacement

RP26853
Wrench
Llave
Clé

RP25620
Set Screw
Tornillo de Ajuste
Vis de Calage

RP64603▲
Handle Kit
Juego de herrajes de la Manija
Manette en kit

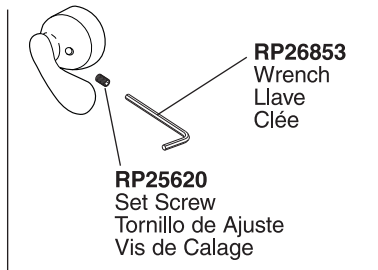

RP51303▲
Tub Spout/Pull-Up Diverter
Tubo de Salida para Bañera/
Botón Desviador de Alzar
Bec/avec dérivation à tirette

Trinsic Tub/Shower Trim Garniture pour Bain/Douche Trinsic

Adorno Trinsic para Bañera/Ducha

Trinsic Tub/Shower

Models/Modelos/Modèles T14059, T14259 & T14459 Series/Series/Seria



RP70175▲
Showerhead
Cabeza de Rogadora
Pomme de Douche



RP6023▲
Shower Arm
Brazo de la Rogadora
Tuyau de Pomme de Douche



RP6025▲
Shower Flange
Pestaña de la Rogadora
Collerette

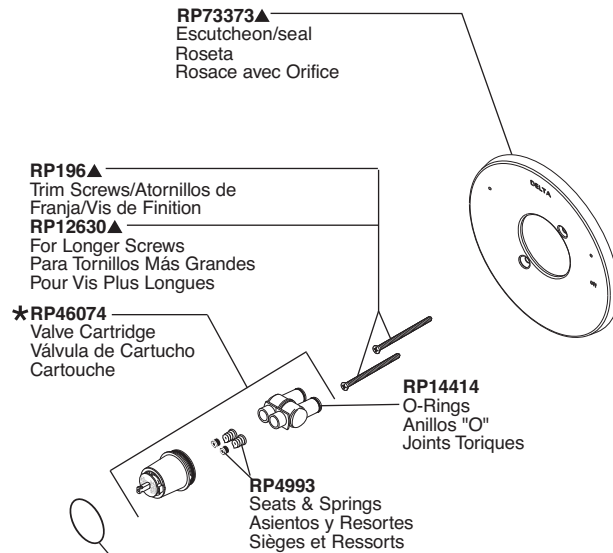

RP73373▲
Escutcheon/seal
Roseta
Rosace avec Orifice

RP196▲
Trim Screws/Atornillos de Franja/Vis de Finition

RP12630▲
For Longer Screws
Para Tornillos Más Grandes
Pour Vis Plus Longues

★RP46074
Valve Cartridge
Válvula de Cartucho
Cartouche

RP14414
O-Rings
Anillos "O"
Joints Toriques

RP4993
Seats & Springs
Asientos y Resortes
Sièges et Ressorts

RP50879▲†
Trim Sleeve
Manga de Franja
Manchon de Finition



RP25620
Set Screw
Tornillo de Ajuste
Vis de Calage

RP26853
Wrench
Llave
Clé

RP23336
O-Ring
Anillo "O"
Joint Torique

RP73375▲
Handle Kit
Juego de herrajes
de la Manija
Manette en kit

RP73371▲
Tub Spout/Pull-Up Diverter
Tubo de Salida para Bañera/
Botón Desviador de Alzar
Bec/avec dérivation à trette

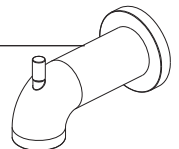

Trinsic Tub/Shower Trim Garniture pour Bain/Douche Trinsic

Adorno Trinsic para Bañera/Ducha

Models/Modelos/Modèles T17059, T17259 & T17459 Series/Series/Seria

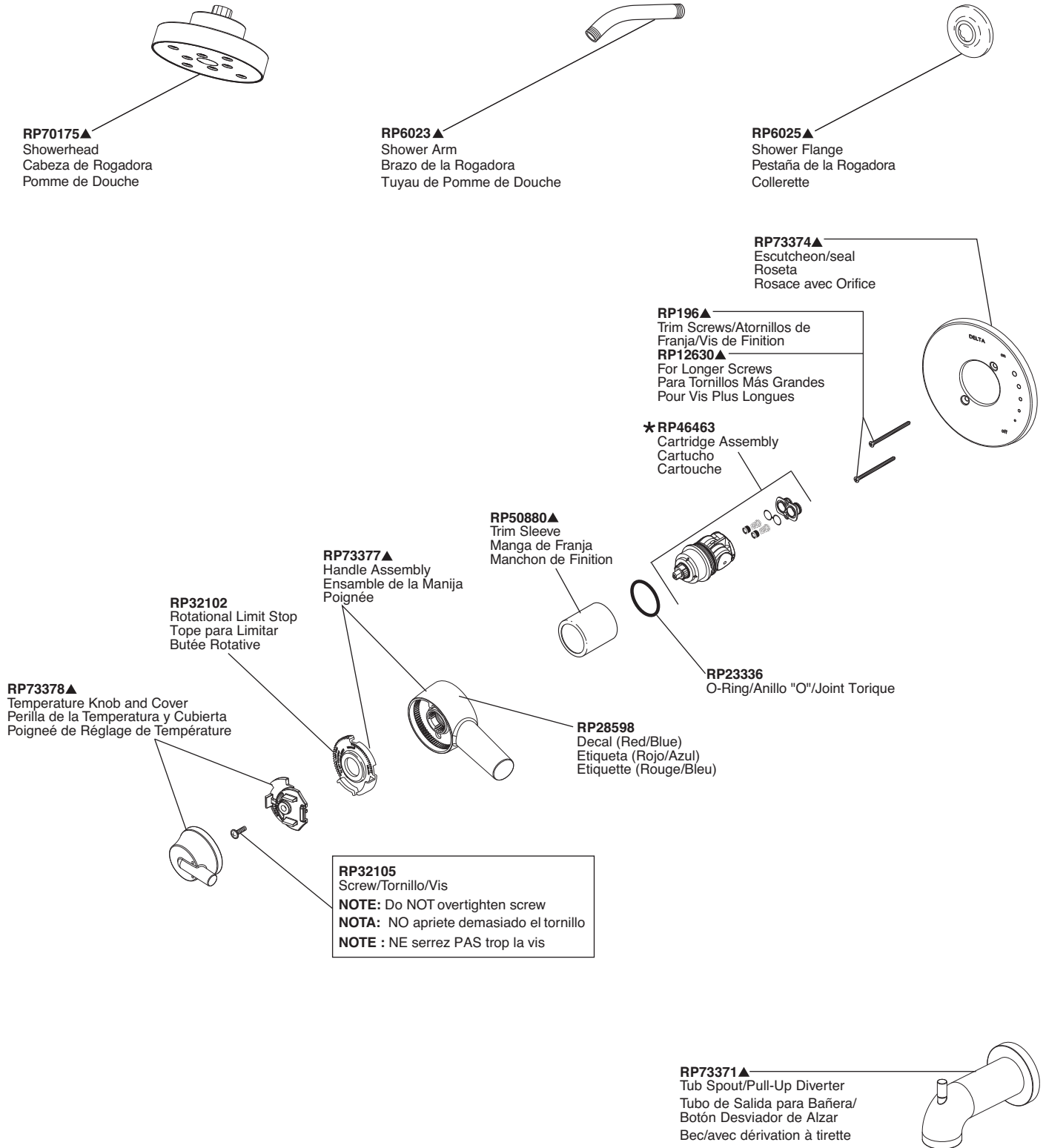

Trinsic™ Roman Tub Trim Garniture de Bain Romain Trinsic™

Adorno Trinsic™ para Bañera Romana

Trinsic™ Roman Tub

Models/Modelos/Modèles T2759 & T4759 Series/Series/Seria

Model / Modelo / Modèle T2759

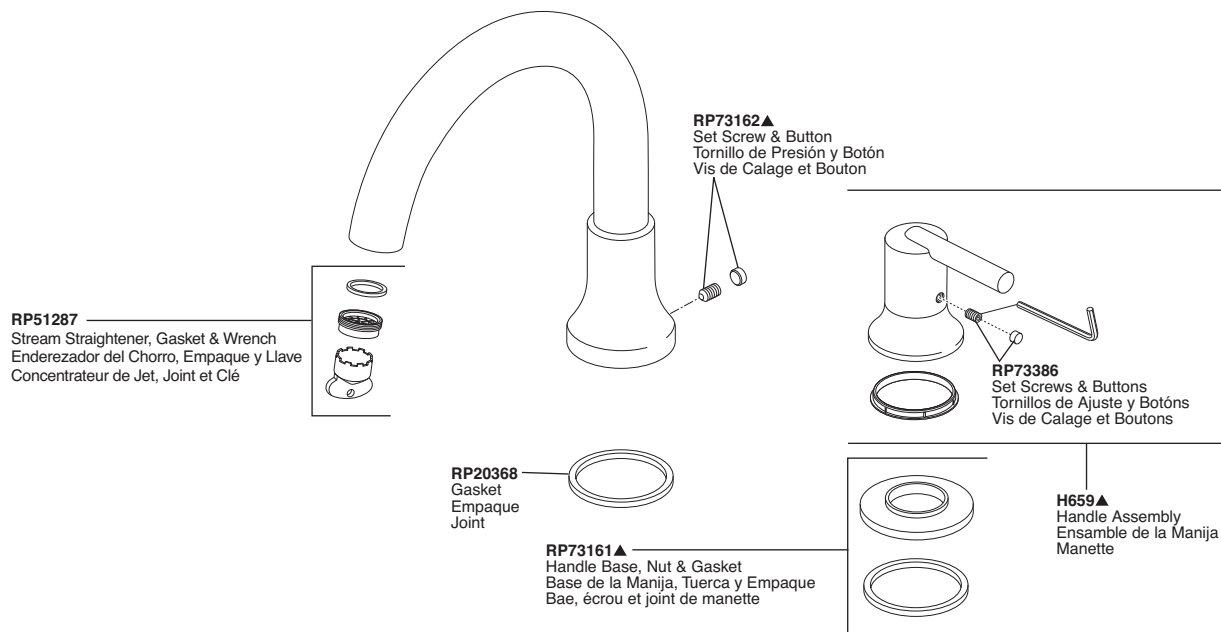

Model / Modelo / Modèle T4759

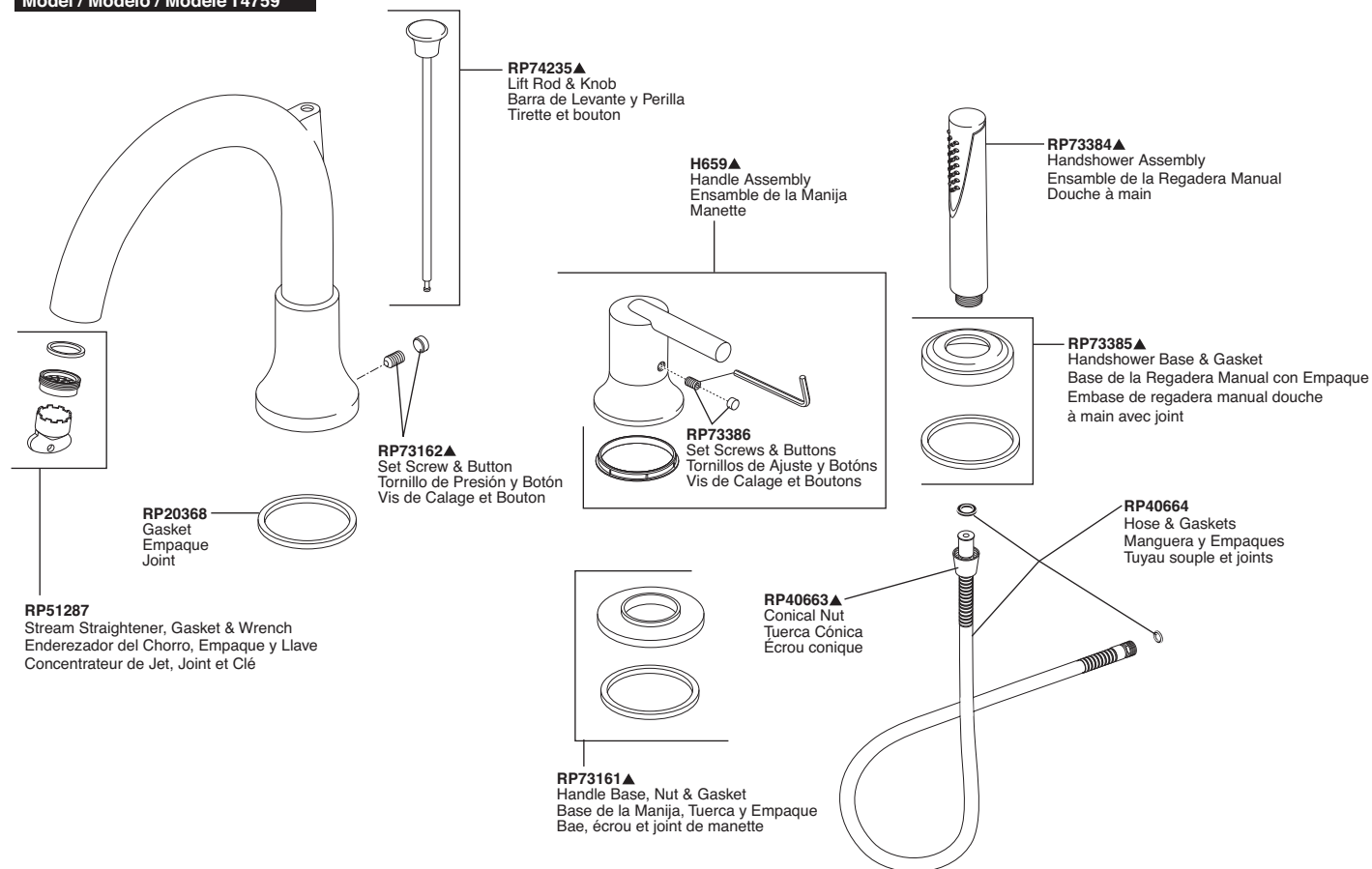

Arzo® Tub/Shower Trim Garniture pour Bain/Douche Arzo®

Adorno Arzo® para Bañera/Ducha

Arzo Tub/Shower

Models/Modelos/Modèles T14086, T14186, T14286, T14286-H2O, T14486-SHQ, T14486, T14486-H2O & T14486-SHQ Series/Series/Seria

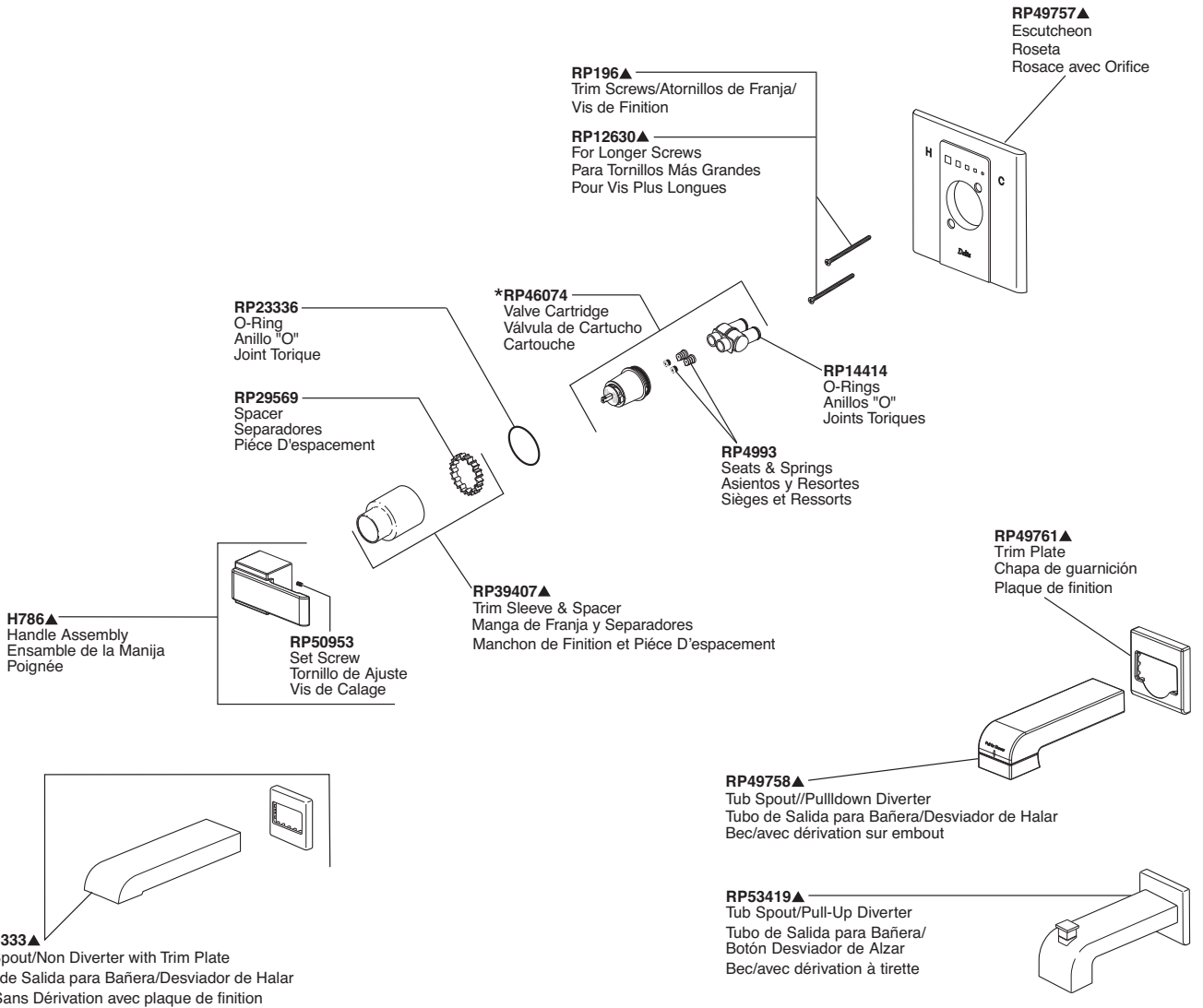
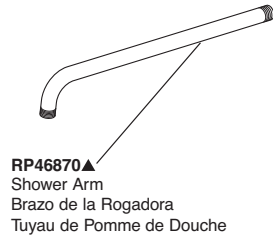
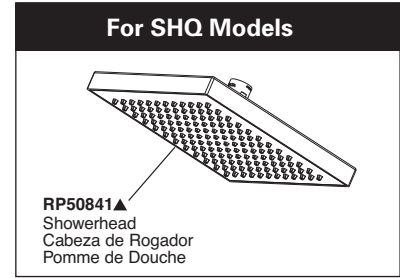
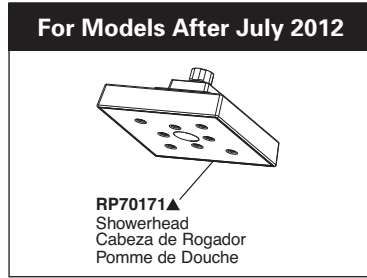
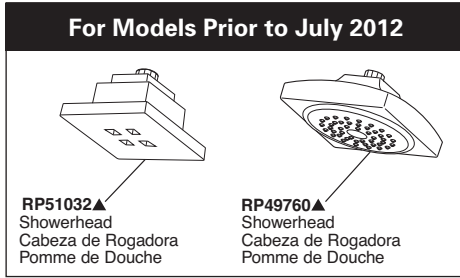

▲ Specify finish / Especifique el Acabado / Précisez le fini

Tub/Shower Trim Garniture pour Bain/Douche

Adorno para Bañera/Ducha

Models/Modelos/Modèles T17086, T17286 & T17486 Series/Series/Seria



RP49760▲
Showerhead
Cabeza de Rogadora
Pomme de Douche

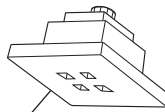

RP51032▲
Showerhead
Cabeza de Rogadora
Pomme de Douche



RP46870▲
Shower Arm
Brazo de la Rogadora
Tuyau de Pomme de Douche



RP46872▲
Shower Flange
Pestaña de la Rogadora
Collerette

RP32105
Screw/Tornillo/Vis

NOTE: Do NOT overtighten screw
NOTA: NO apriete demasiado el tornillo
NOTE: NE serrez PAS trop la vis

RP28598
Decal (Red/Blue)
Etiqueta (Rojo/Azul)
Etiquette (Rouge/Bleu)

RP50880▲
Trim Sleeve
Manga de Franja
Manchon de Finition

RP32102
Rotational Limit Stop
Tope para Limitar
Butée Rotative

RP53418▲
Handle Assembly
Ensamble de la Manija
Poignée

RP53417▲
Temperature Knob and Cover
Perilla de la Temperatura y Cubierta
Poignée de Réglage de Température

RP196▲
Trim Screws
Atornillos de Franja
Vis de Finition

RP12630▲
For Longer Screws
Para Tornillos Más Grandes
Pour Vis Plus Longues

*** RP46463**
Cartridge Assembly
Cartucho
Cartouche

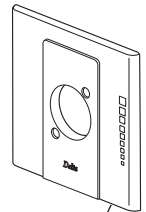

RP53420▲
Escutcheon
Roseta
Rosace avec Orifice

RP23336
O-Ring
Anillo "O"
Joint Torique

RP49761▲
Trim Plate
Chapa de guarnición
Plaque de finition

RP49758▲
Tub Spout/Pull-Down Diverter
Tubo de Salida para Bañera/Desviador de Halar
Bec/avec dérivation sur embout

RP53419▲
Tub Spout/Pull-Up Diverter
Tubo de Salida para Bañera/
Botón Desviador de Alzar
Bec/avec dérivation à tirette

† Designates the accent color on split finish models
† Designa el color para acentuar los modelos con acabados divididos
† Désigne la couleur contrastante sur les modèles à deux finis

▲ Specify finish / Especifique el Acabado / Précisez le fini

Vero® Tub/Shower Trim

Garniture pour Bain/Douche Vero®

Adorno Vero® para Bañera/Ducha

Vero Tub/Shower

Models/Modelos/Modèles T14053, T14253, T14253-H2O, T14453 & T14453-H2O Series/Series/Seria

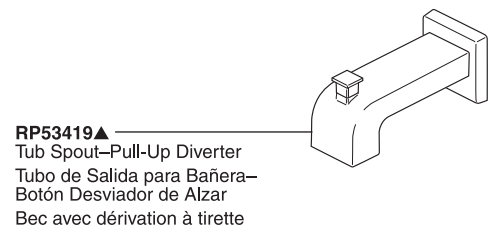
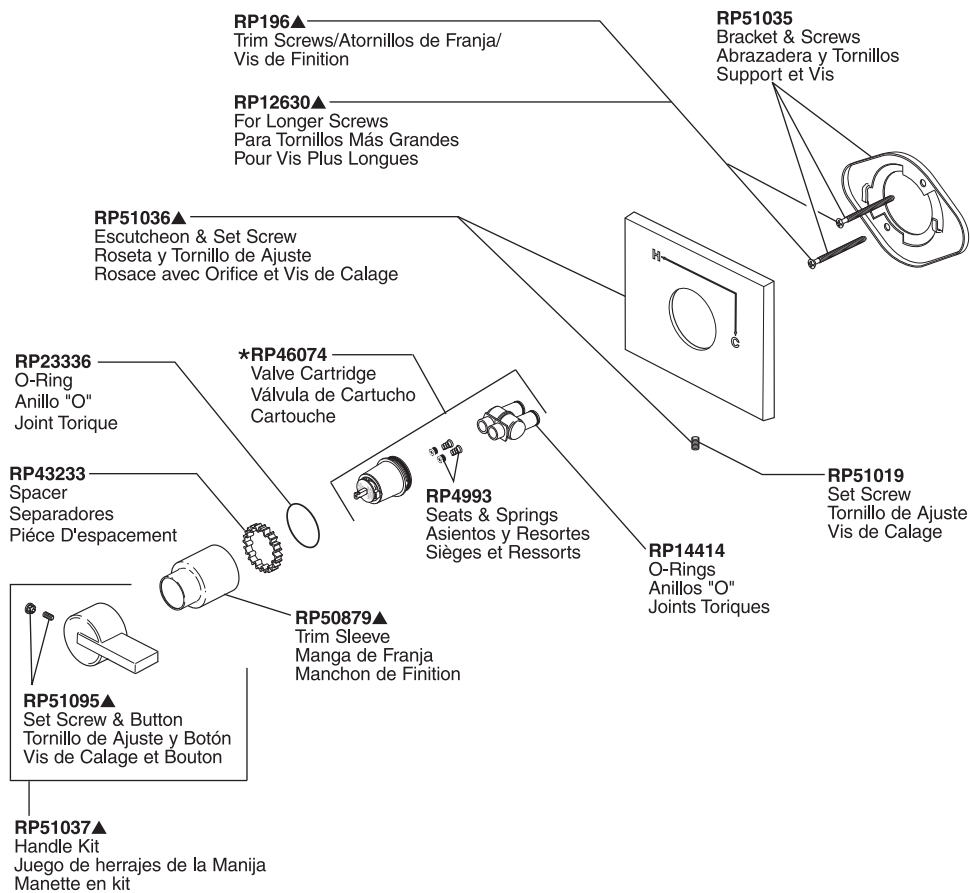
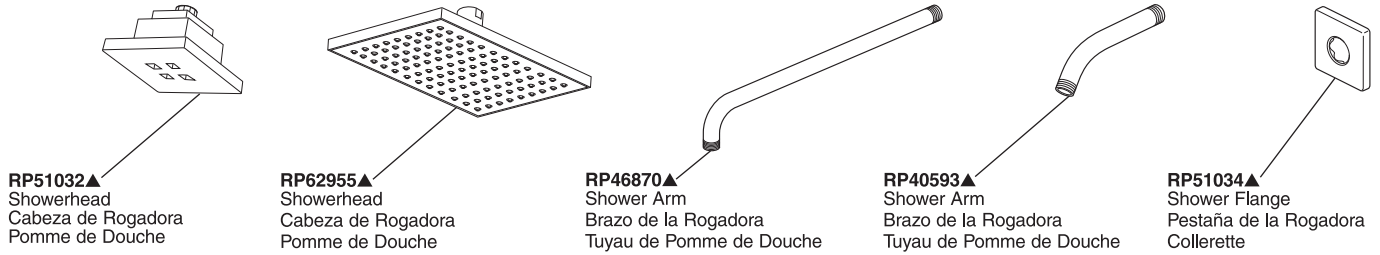

Tub/Shower Trim

Garniture pour Bain/Douche

Adorno para Bañera/Ducha

Models/Modelos/Modèles T17053, T17153, T17253, T17453,
T17253-H2O & T17453-H2O Series/Series/Seria

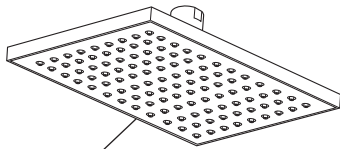

RP62955▲
Showerhead
Cabeza de Rogadora
Pomme de Douche



RP46870▲
Shower Arm
Brazo de la Rogadora
Tuyau de Pomme de Douche



RP40593▲
Shower Arm
Brazo de la Rogadora
Tuyau de Pomme de Douche

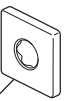

RP51034▲
Shower Flange
Pestaña de la Rogadora
Collerette

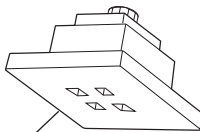

RP51032▲
Showerhead
Cabeza de Rogadora
Pomme de Douche

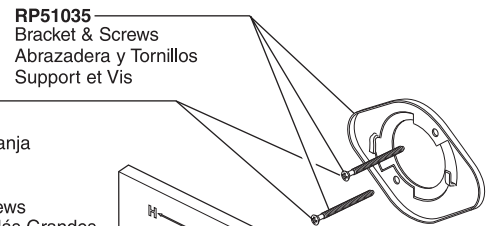

RP51035
Bracket & Screws
Abrazadera y Tornillos
Support et Vis

RP196▲
Trim Screws
Atornillos de Franja
Vis de Finition

RP12630▲
For Longer Screws
Para Tornillos Más Grandes
Pour Vis Plus Longues

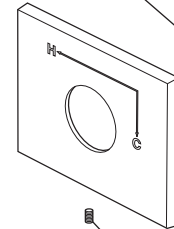

RP62958▲
Escutcheon
Roseta
Rosace avec Orifice

RP32105
Screw/Tornillo/Vis

NOTE: Do NOT overtighten screw
NOTA: NO apriete demasiado el tornillo
NOTE: NE serrez PAS trop la vis

★RP46463
Cartridge Assembly
Cartucho
Cartouche

RP50880▲
Trim Sleeve
Manga de Franja
Manchon de Finition

RP32102
Rotational Limit Stop
Tope para Limitar
Butée Rotative

RP23336
O-Ring/Anillo "O"/Joint Torique

RP28598
Decal (Red/Blue)
Etiqueta (Rojo/Azul)
Etiquette (Rouge/Bleu)

RP62957▲
Handle Assembly
Ensamble de la Manija
Poignée

RP62956▲
Temperature Knob and Cover
Perilla de la Temperatura y Cubierta
Poignée de Réglage de Température

RP53419▲
Tub Spout—Pull-Up Diverter
Tubo de Salida para Bañera—
Botón Desviador de Alzar
Bec avec dérivation à tirette

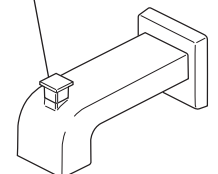

Tub/Shower Trim Garniture pour Bain/Douche

Adorno para Bañera/Ducha

Models/Modelos/Modèles T17T053, T17T253 & T17T453 Series/Series/Seria

Vero Tub/Shower

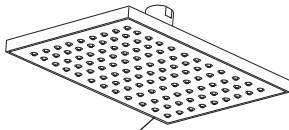

RP62955▲
Showerhead
Cabeza de Regadera
Pomme de Douche

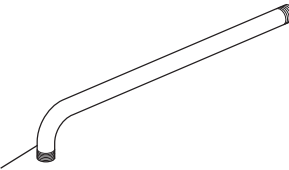

RP46870▲
Shower Arm
Brazo de Regadera
Tuyau de Pomme de Douche



RP51034▲
Shower Flange
Pestaña de la Regadera
Collerette

RP196▲
Trim Screws
Atornillos de Franja
Vis de Finition

RP12630▲
For Longer Screws
Para Tornillos Más Grandes
Pour Vis Plus Longues

RP51035
Bracket & Screws
Abrazadera y Tornillos
Support et Vis

RP62958▲
Escutcheon/Roseta/Rosace

RP50879▲
Trim Sleeve
Manga de Franja
Manchon de Finition

RP62960▲
Handle Assembly
Ensamble de la Manija
Poignée

RP51019
Set Screw
Tornillo de Ajuste
Vis de Calage

RP47201*
Cartridge Assembly
Cartucho
Cartouche

RP23336
O-Ring
Anillo "O"
Joint Torique

RP50465
Set Screw & Wrench
Tornillo de Ajuste y Llave
Vis de calage et Clé

RP62959▲
Temperature Knob, Cover & Screw
Perilla de la Temperatura, Cubierta y Tornillo
Poigné de Réglage de Température et Vis

RP53419▲
Tub Spout/Pull-Up Diverter
Tubo de Salida para Bañera/
Botón Desviador de Alzar
Bec/avec dérivation à tirette

Vero™ Collection Roman Tub Trim Garniture de Bain Romain Collection Vero™

Adorno para Bañera Romana de la Colección Vero™

Vero™ Roman Tub

Models/Modelos/Modèles T2753 & T4753 Series/Series/Seria

Model / Modelo / Modèle T2753

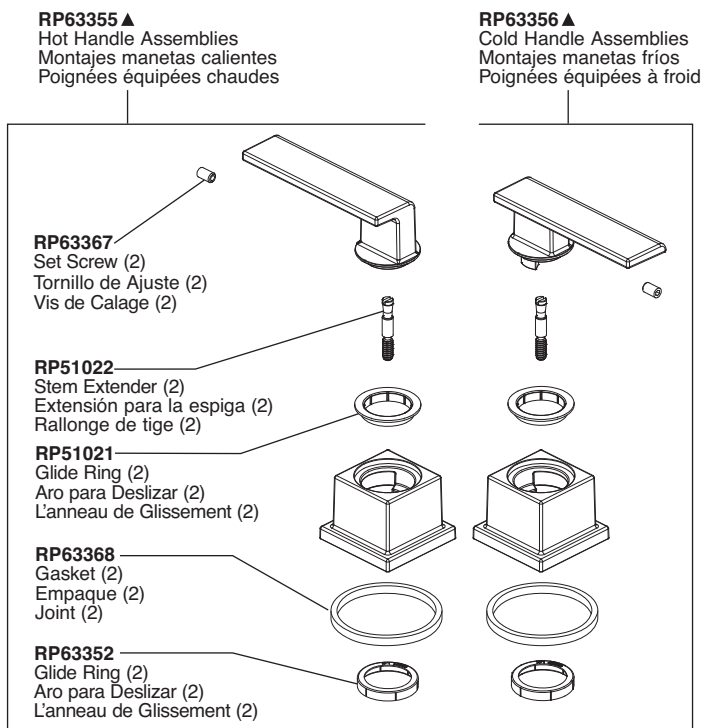
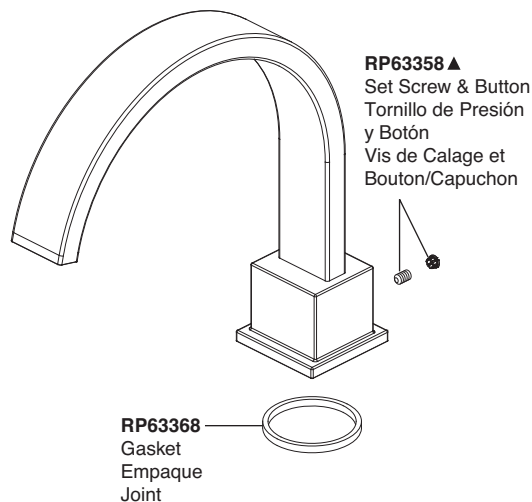

Model / Modelo / Modèle T4753

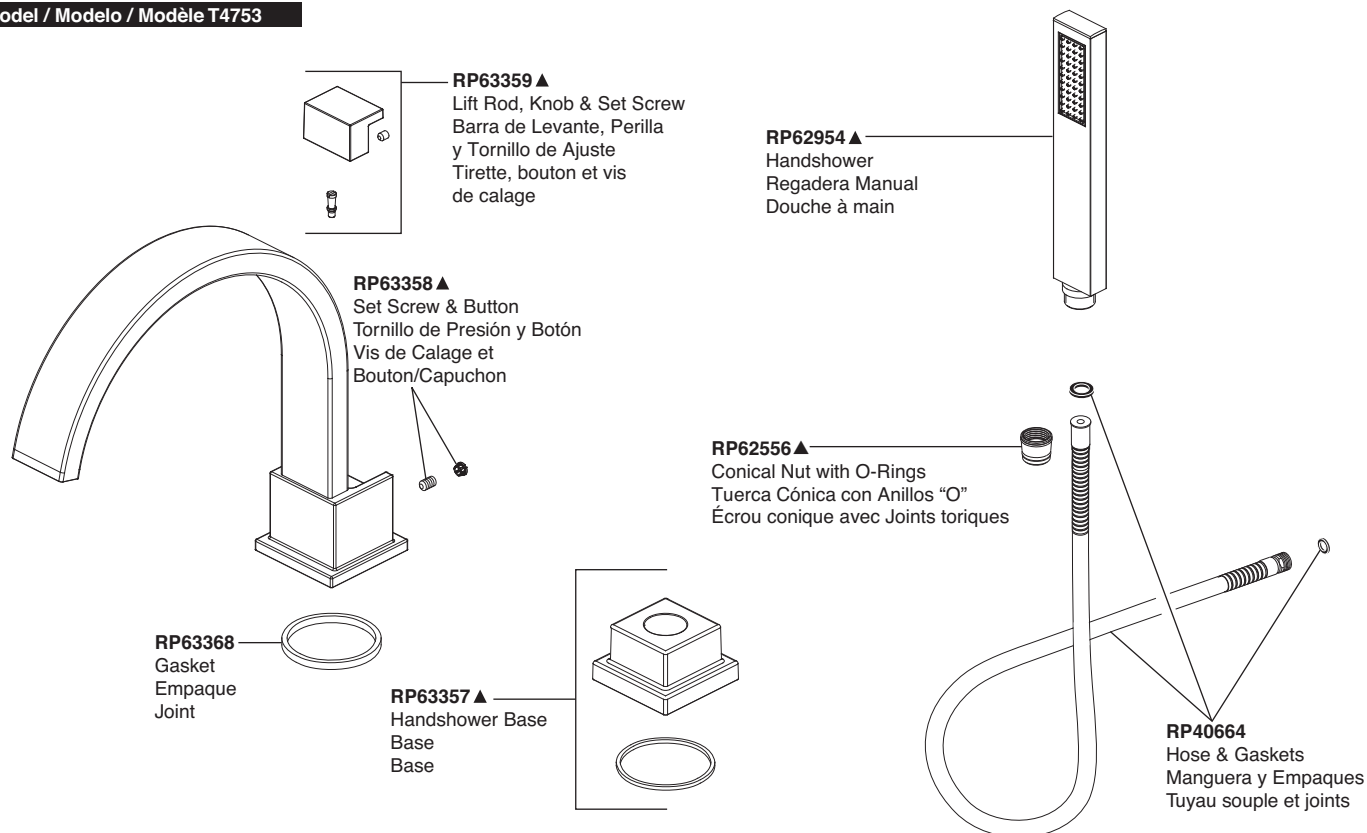

Victorian® Tub/Shower Trim

Garniture pour Bain/Douche Victorian®

Adorno Victorian® para Bañera/Ducha

Models/Modelos/Modèles T14055-LHP, T14155-LHP, T14255-LHP, T14255-H2OLHP, T14455-LHP & T14455-H2OLHP, Series/Series/Seria

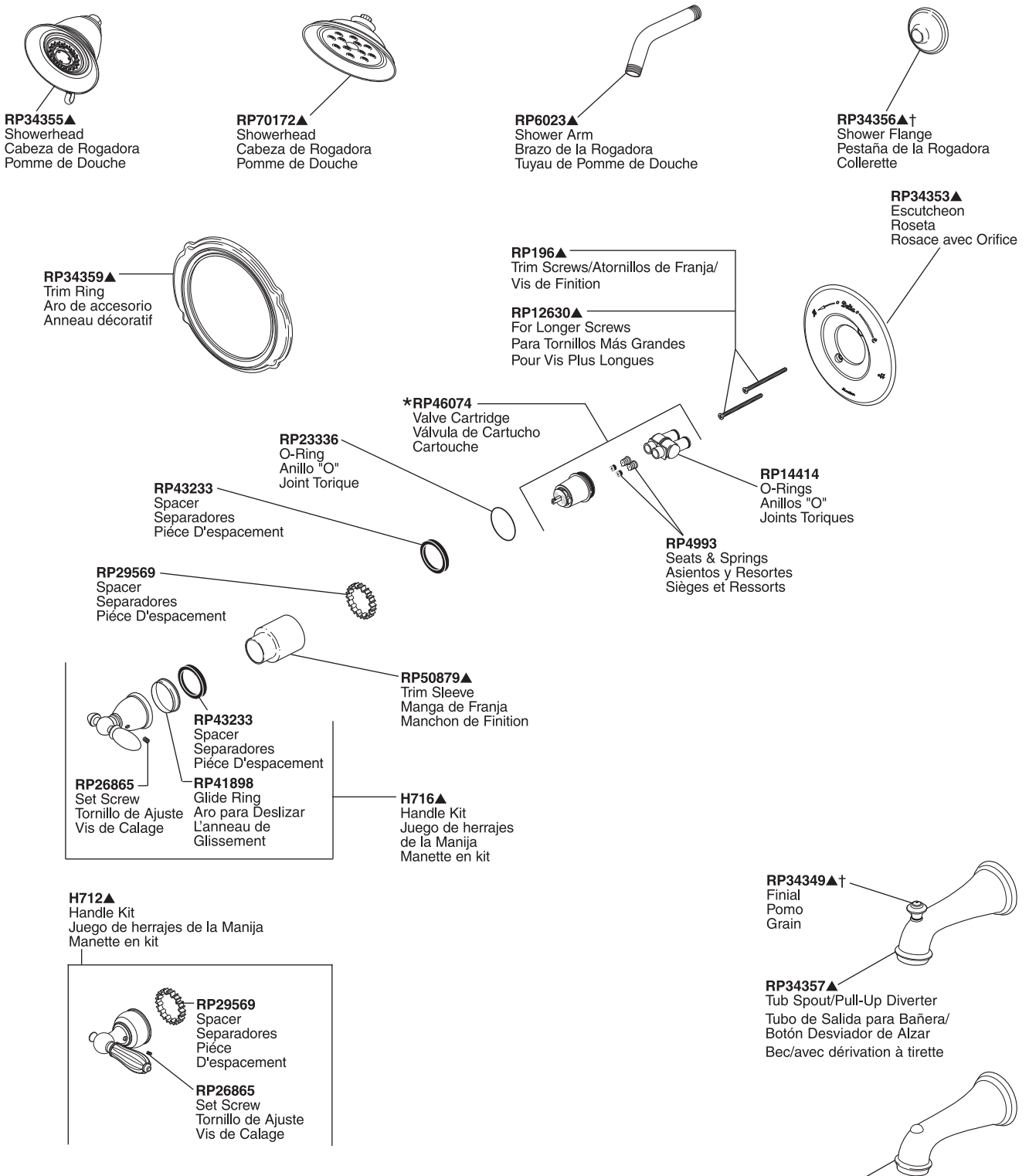

† Designates the accent color on split finish models.
† Designa el color para acentuar los modelos con acabados divididos.
† Désigne la couleur contrastante sur les modèles à deux finis

Tub/Shower Trim Garniture pour Bain/Douche

Adorno para Bañera/Ducha

Models/Modelos/Modèles T17055, T17155, T17255, T17455,
T17255-H2O & T17455-H2O Series/Series/Seria



RP34355▲
Showerhead
Cabeza de Rogadora
Pomme de Douche

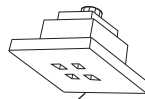

RP51032▲
Showerhead
Cabeza de Rogadora
Pomme de Douche

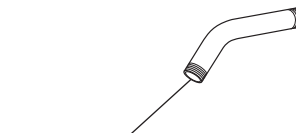

RP6023▲
Shower Arm
Brazo de la Rogadora
Tuyau de Pomme de Douche



RP34356▲†
Shower Flange
Pestaña de la Rogadora
Collerette



RP70172▲
Showerhead
Cabeza de Rogadora
Pomme de Douche

RP196▲
Trim Screws
Atornillos de Franja
Vis de Finition

RP12630▲
For Longer Screws
Para Tornillos Más Grandes
Pour Vis Plus Longues

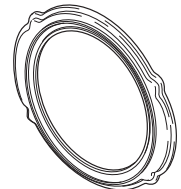

RP34359▲
Trim Ring
Aro de accesorio
Anneau décoratif

RP32105
Screw/Tornillo/Vis

NOTE: Do NOT overtighten screw
NOTA: NO apriete demasiado el tornillo
NOTE: NE serrez PAS trop la vis

***RP46463**
Cartridge Assembly
Cartucho
Cartouche

RP50880▲†
Trim Sleeve
Manga de Franja
Manchon de Finition

RP28598
Decal (Red/Blue)
Etiqueta (Rojo/Azul)
Étiquette (Rouge/Bleu)

RP32102
Rotational Limit Stop
Tope para Limitar
Butée Rotative

RP23336
O-Ring
Anillo "O"
Joint Torique

RP34354▲
Escutcheon
Roseta
Rosace avec Orifice



RP32103▲
Handle Assembly
Ensamble de la Manija
Poignée

RP26852
Spindle/Husillo/Tige

A716▲
Victorian Accent

A712
Traditional Accent

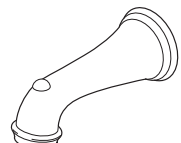

RP43028▲
Tub Spout/
Tubo de Salida para Bañera/
Sin Desviador
Bec/Sans Dérivation

RP34358▲
Temperature Knob and Cover
Perilla de la Temperatura y Cubierta
Poigné de Réglage de Température

RP34349▲†
Finial
Pomo
Grain

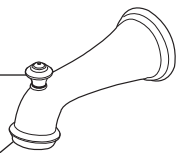

RP34357▲
Tub Spout/Pull-Up Diverter
Tubo de Salida para Bañera/
Botón Desviador de Alzar
Bec/avec dérivation à tirette

† Designates the accent color on split finish models
† Designa el color para acentuar los modelos con acabados divididos
† Désigne la couleur contrastante sur les modèles à deux finis

Tub/Shower Trim Garniture pour Bain/Douche

Adorno para Bañera/Ducha

Models/Modelos/Modèles T17T055, T17T255 & T17T455 Series/Series/Seria



RP34355▲
Showerhead
Cabeza de Regadera
Pomme de Douche



RP40593▲
Shower Arm
Brazo de Regadera
Tuyau de Pomme de Douche



RP34356▲
Shower Flange
Pestaña de la Regadera
Collerette

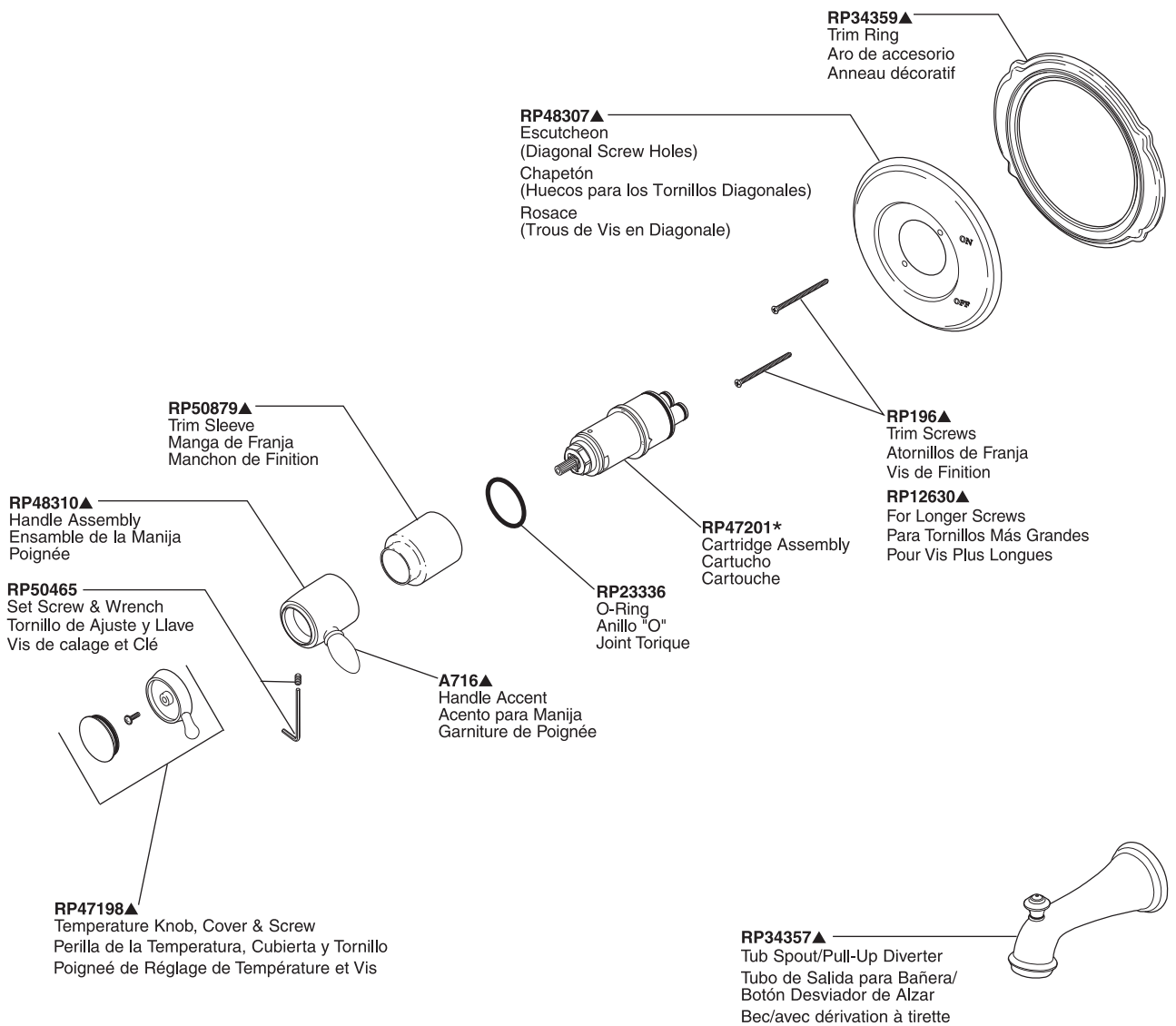

Victorian® Collection Jetted Shower™ Trim Garniture Jetted Shower™ Collection Victorian®

Adorno para Jetted Shower™ de la Colección Victorian®

Victorian® Jetted Shower™

Models/Modelos/Modèles T18455 Series/Series/Seria

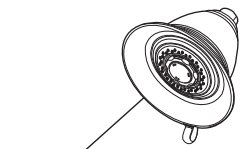

RP34355▲
Showerhead
Cabeza de Regadera
Pomme de Douche



RP6023▲
Shower Arm
Brazo de Regadera
Tuyau de Pomme de Douche



RP34356▲
Shower Flange
Pestaña de la Regadera
Collerette

RP37898
Labels/Etiquetas/Étiquettes

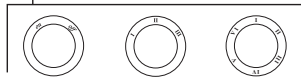

RP34791
Wrench/Llave/Clée



RP34785
Pivot Ring & Seal
Aro Pivotado y Empaque
Anneau de pivotement et joint

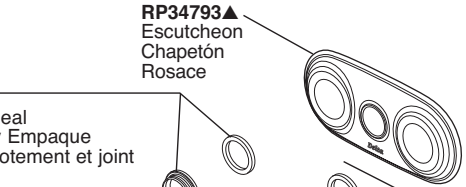

RP37901▲
Sleeve
Manguito
Manchon

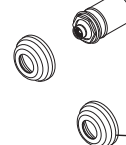

RP37895▲
Trim Ring
Anillo de Franja
Anneau de Finition



RP26865
Set Screw
Tornillo de Ajuste
Vis de Calage

RP37896▲
Handle w/Set Screw
Manija con Tornillo de Ajuste
Manette avec Vis de Calage



RP34793▲
Escutcheon
Chapetón
Rosace

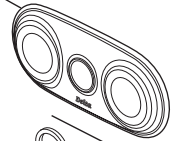

RP37891
Jet Sleeve
Manga del Chorro
Manchon de Pulsation

RP37897▲
Bonnet
Bonete
Chapeau

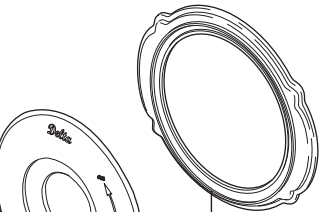

RP46463
Cartridge Assembly
Cartucho
Cartouche

RP50880▲
Trim Sleeve
Manga de Franja
Manchon de Finition



RP23336
O-Ring
Anillo "O"
Joint Torique



RP34354▲
Escutcheon (Diag. Screw Holes)
Chapetón (Huecos para los Tornillos Diagonales)
Rosace (Trous de Vis en Diagonale)

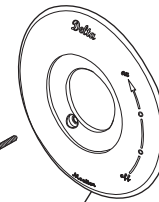

RP196▲
Trim Screws
Atornillos de Franja
Vis de Finition

RP12630▲
For Longer Screws
Para Tornillos Más Grandes
Pour Vis Plus Longues

RP32103▲
Handle Assembly
Ensamble de la Manija
Poignée

RP32105
Screw*
Tornillo*
Vis*



RP32102
Rotational Limit Stop
Tope para Limitar
Butée Rotative

RP34358▲
Temperature Knob and Cover
Perilla de la Temperatura y Cubierta
Poignée de Réglage de Température



RP28598
Decal (Red/Blue)
Etiqueta (Rojo/Azul)
Étiquette (Rouge/Bleu)

A716▲

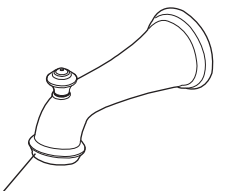

RP34357▲ (Metal/Metálico/Métal)
Tub Spout/Pull-Up Diverter
Tubo de Salida para Bañera/
Botón Desviador de Alzar
Bec/avec dérivation à tirette

*NOTE: Do NOT overtighten screw./ **NOTA:** NO apriete demasiado el tornillo./ **NOTE:** NE serrez PAS trop la vis.

▲ Specify finish / Especifique el Acabado / Précisez le fini

Victorian® Jetted Shower XO® Trim Garniture Jetted Shower XO® Victorian®

Adorno Victorian® para Jetted Shower XO®

Victorian® Jetted Shower XO®

Model/Modelo/Modèle T18255-XO Series/Series/Seria

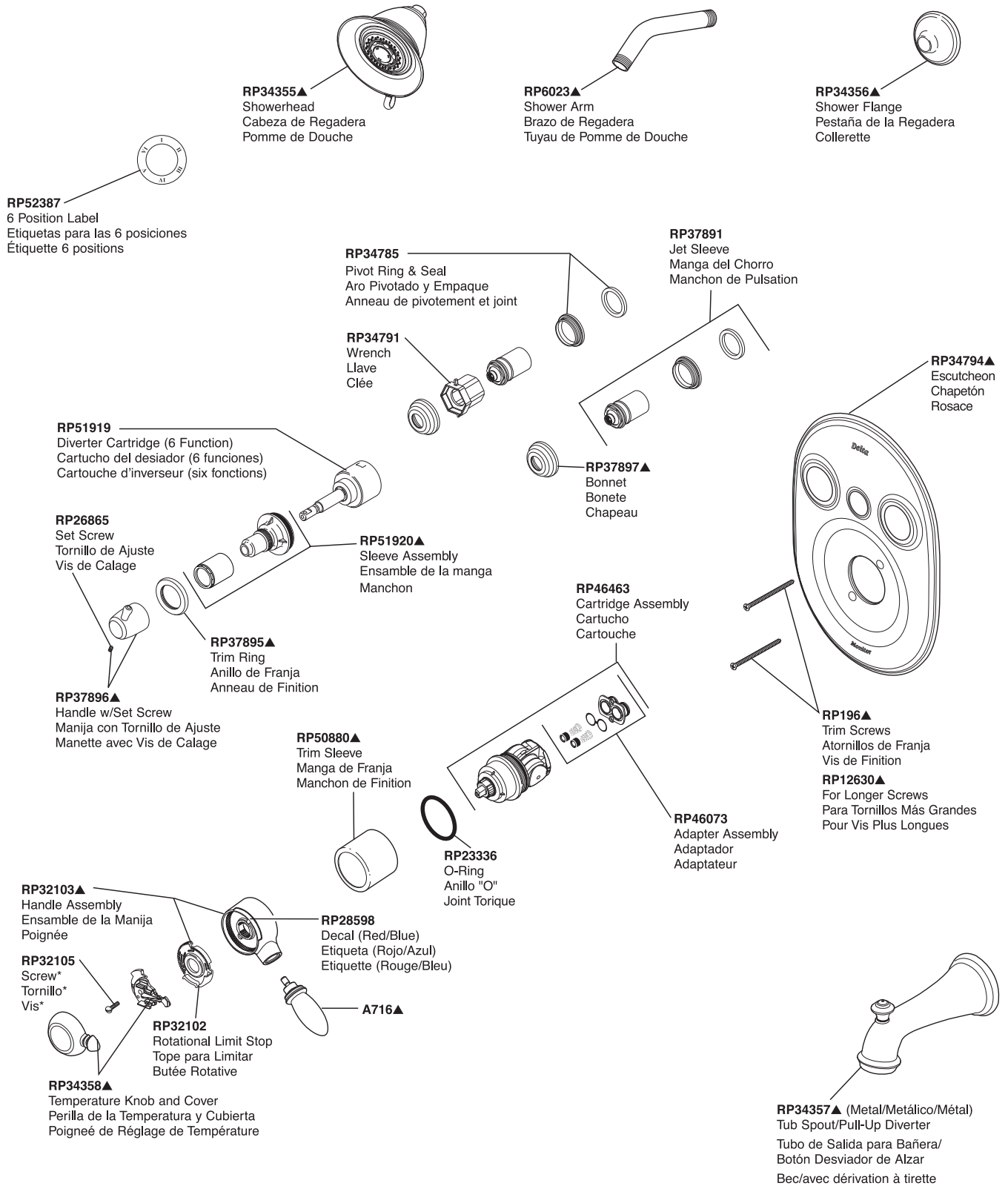

*NOTE: Do NOT overtighten screw./ **NOTA:** NO apriete demasiado el tornillo./ **NOTE:** NE serrez PAS trop la vis.

▲ Specify finish / Especificque el Acabado / Précisez le fini

Victorian® Collection Roman Tub Trim Garniture de Bain Romain Collection Victorian®

Adorno para Bañera Romana de la Colección Victorian®

Victorian® Roman Tub

Model/Modelo/Modèle T2755 Series/Series/Seria

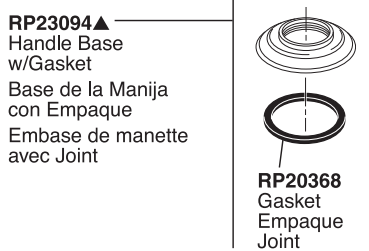
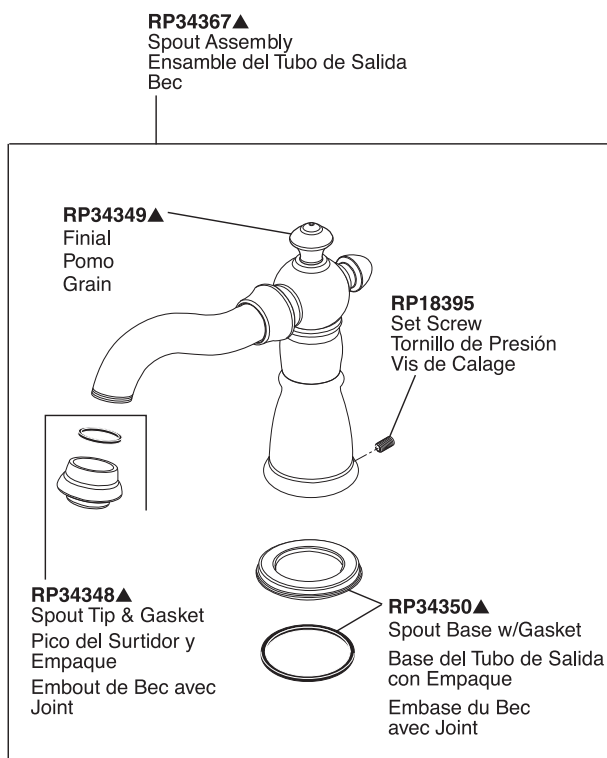

Victorian® Collection Roman Tub Trim Garniture de Bain Romain Collection Victorian®

Adorno para Bañera Romana de la Colección Victorian®

Models/Modelos/Modèles T4755 Series/Series/Seria

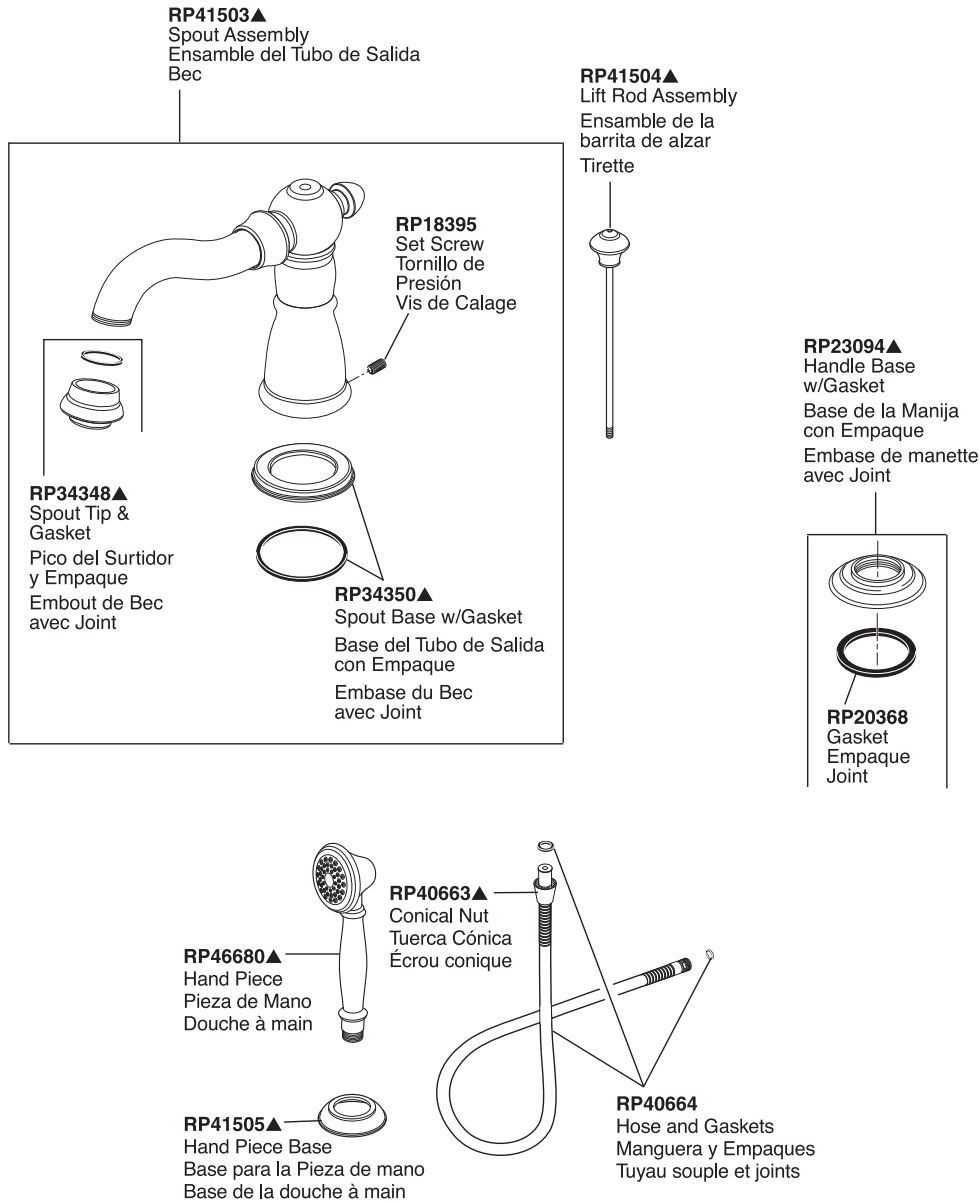

Refer to handle and rough-in sections for additional information. / Refiérase a las secciones de las manijas y la tubería interna para información adicional. / Référez-vous aux sections manette et brut pour plus d'information.

Victorian® Roman Tub Handshower and Diverter

Douche à Main et Dérivation Pour Bain Romain Collection Victorian®

Douche à Main et Dérivation Pour Bain Romain de la Colección Victorian®

Victorian® Roman Tub

Model/Modelo/Modèle RP33791 Series/Series/Seria

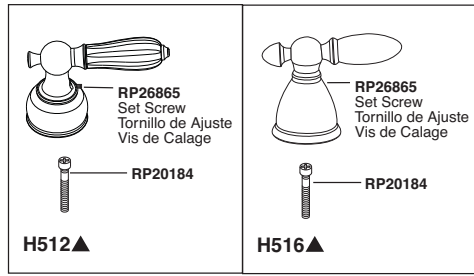
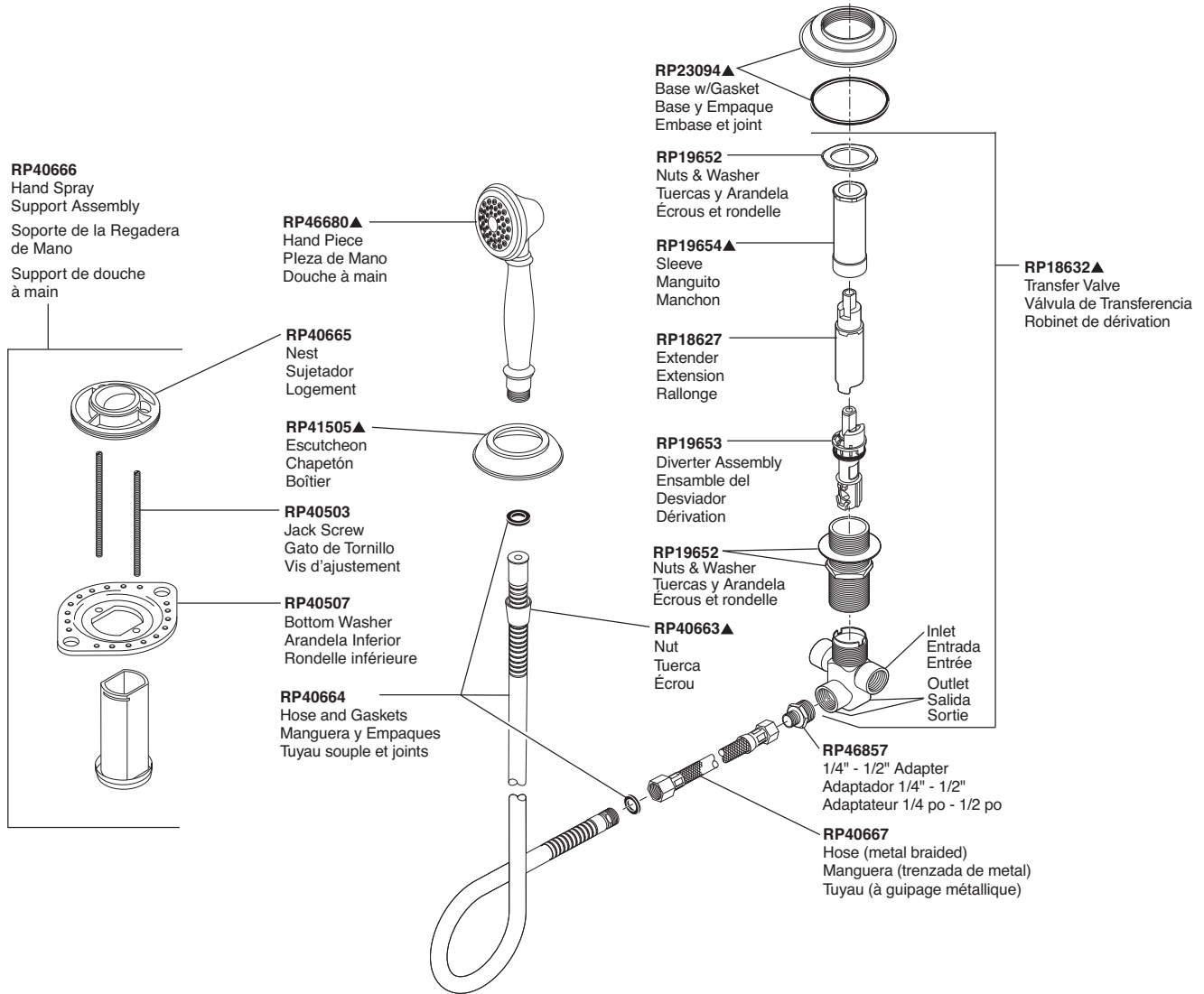

▲ Specify finish / Especifique el Acabado / Précisez le fini

1400 Series Tub/Shower Trim Garniture pour Bain/Douche 1400 Series

Adorno 1400 Series para Bañera/Ducha

Models/Modelos/Modèles T14088, T14188, T14288 & T14488 Series/Series/Seria



RP40594▲
Showerhead
Cabeza de Rogadora
Pomme de Douche



RP40593▲
Shower Arm
Brazo de la Rogadora
Tuyau de Pomme de Douche



RP40592▲
Shower Flange
Pestaña de la Rogadora
Collerette

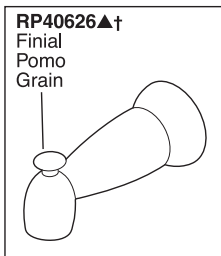
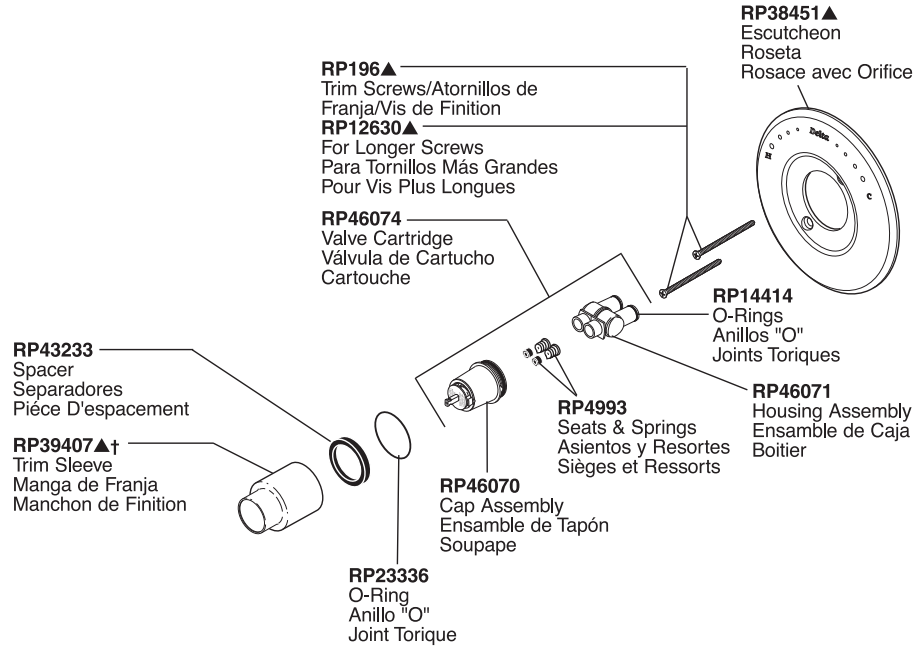

RP40626▲†
Finial
Pomo
Grain

RP40625▲
Tub Spout/Pull-Up Diverter
Tubo de Salida para Bañera/Botón
Desviador de Alzar
Bec/avec dérivation à tirette

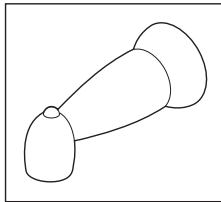

RP43312▲
Tub Spout/Non Diverter
Tubo de Salida para Bañera/
Sin Desviador
Bec/Sans Dérivation

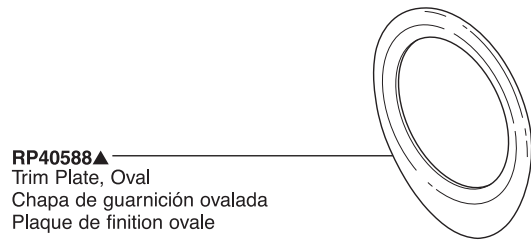

RP40588▲
Trim Plate, Oval
Chapa de guarnición ovalada
Plaque de finition ovale



RP40589▲
Trim Plate, Star
Chapa de guarnición en forma de estrella
Plaque de finition étoilée

1700 Series Tub/Shower Trim Garniture pour Bain/Douche 1700 Series

Adorno 1700 Series para Bañera/Ducha

Models/Modelos/Modèles T17188, T17288 & T17488 Series/Series/Seria



RP40594▲
Showerhead
Cabeza de Rogadora
Pomme de Douche

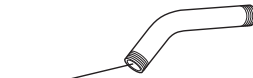

RP40593▲
Shower Arm
Brazo de la Rogadora
Tuyau de Pomme de Douche



RP40592▲
Shower Flange
Pestaña de la Rogadora
Collerette

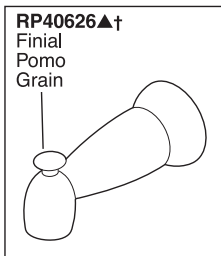
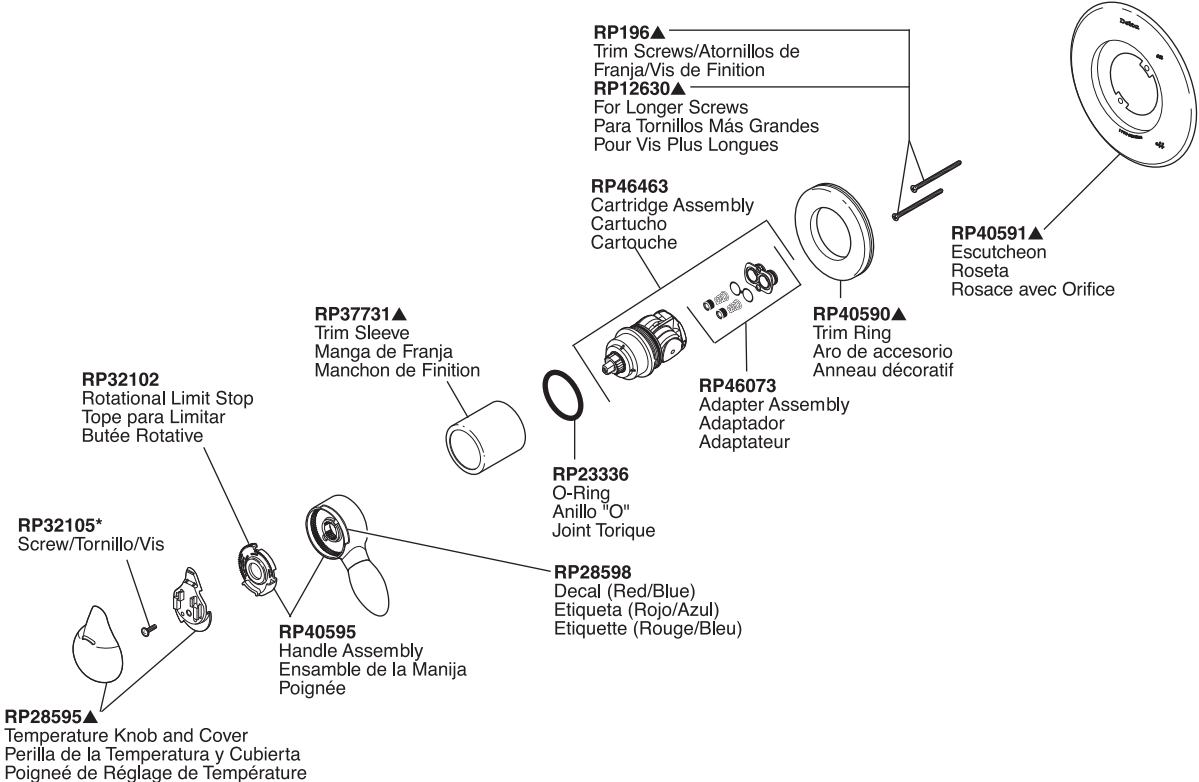

RP40626▲†
Finial
Pomo
Grain

RP40625▲
Tub Spout/Pull-Up Diverter
Tubo de Salida para Bañera/Botón
Desviador de Alzar
Bec/avec dérivation à tirette

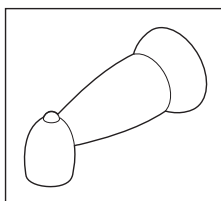

RP43312▲
Tub Spout/Non Diverter
Tubo de Salida para Bañera/
Sin Desviador
Bec/Sans Dérivation

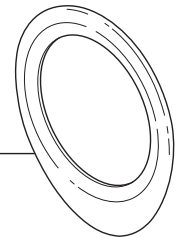

RP40588▲
Trim Plate, Oval
Chapa de guarnición ovalada
Plaque de finition ovale

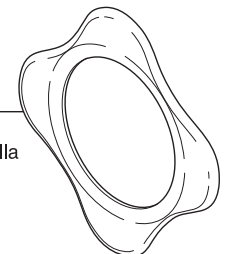

RP40589▲
Trim Plate, Star
Chapa de guarnición en forma de estrella
Plaque de finition étoilée

Classic Tub/Shower Trim Garniture pour Bain/Douche Classique

Adorno Clásica para Bañera/Ducha

Models/Modelos/Modèles T13020, T13020-DPE, T13022, T13120, T13122, T13220, T13220-DPE, T13220-H20, T13220-H20T, T13222, T13420, T13420-DPE, T13420-H20, T13420-H20T & T13422 Series/Series/Seria



RP54752▲
Showerhead
Cabeza de Rogadora
Pomme de Douche



RP38357▲
Showerhead
Cabeza de Rogadora
Pomme de Douche



RP40594▲
Showerhead
Cabeza de Rogadora
Pomme de Douche



RP46384▲
Showerhead
Cabeza de Rogadora
Pomme de Douche

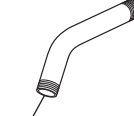

RP6023▲
Shower Arm
Brazo de la Rogadora
Tuyau de Pomme de Douche



RP38452▲
Shower Flange
Pestaña de la Rogadora
Collerette

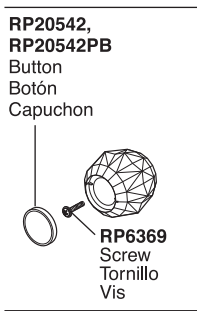

RP20542, RP20542PB
Button
Botón
Capuchon

RP6369
Screw
Tornillo
Vis

H71, H71PB
Handle Kit
Juego de herrajes de la Manija
Manette en kit

RP21633▲
Deep Escutcheon
Roseta
Rosace avec Orifice

RP19809▲
Escutcheon
Roseta
Rosace avec Orifice

RP196▲
Trim Screws/Atornillos de Franja/
Vis de Finition

RP12630▲
For Longer Screws
Para Tornillos Más Grandes
Pour Vis Plus Longues

RP23336
O-Ring
Anillo "O"
Joint Torique

RP29569
Spacer
Separadores
Pièce D'espacement

RP48717▲
Handle Kit
Juego de herrajes de la Manija
Manette en kit

★ RP46074
Valve Cartridge
Válvula de Cartucho
Cartouche

RP4993
Seats & Springs
Asientos y Resortes
Sièges et Ressorts

RP14414
O-Rings
Anillos "O"
Joints Toriques

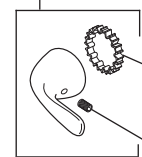

RP29569
Spacer
Separadores
Pièce D'espacement

RP26865
Set Screw
Tornillo de Ajuste
Vis de Calage

RP50879▲
Trim Sleeve
Manga de Franja
Manchon de Finition

* Refer to page 2 for more information.
Consulte con la página 2 para más información.
Pour obtenir de plus amples renseignements, reportez-vous à la page 2.

RP36498▲
Tub Spout/Non Diverter
Tubo de Salida para Bañera/
Sin Desviador
Bec/Sans Dérivation

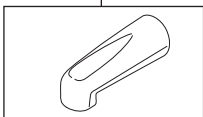

RP5833▲
Tub Spout/Non Diverter
Tubo de Salida para Bañera/
Sin Desviador
Bec/Sans Dérivation

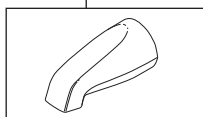

RP19895▲
(Metal/Metálico/Métal)
Tub Spout/Pull-Up Diverter
Tubo de Salida para Bañera/
Botón Desviador de Alzar
Bec/avec Dérivation à Tirette

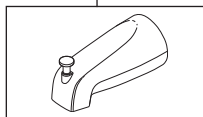

RP17453
RP17454▲
(Metal/Metálico/Métal)
Tub Spout/Pull-Down Diverter
Tubo de Salida para Bañera/
Desviador de Halar
Bec/Avec Dérivation sur Embout

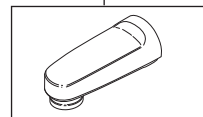

Tub/Shower Trim

Garniture pour Bain/Douche

Adorno para Bañera/Ducha

Classic Tub/Shower

Models/Modelos/Modèles T17030, T17130, T17230, T17430,
T17230-H2O & T17430-H2O Series/Series/Seria

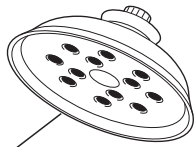

RP70173▲
Showerhead
Cabeza de Rogadora
Pomme de Douche



RP40594▲
Showerhead
Cabeza de Rogadora
Pomme de Douche

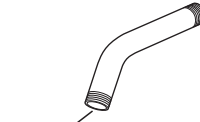

RP6023▲
Shower Arm
Brazo de la Rogadora
Tuyau de Pomme de Douche



RP6025▲†
Shower Flange
Pestaña de la Rogadora
Collerette

RP32105
Screw/Tornillo/Vis

NOTE: Do NOT overtighten screw
NOTA: NO apriete demasiado el tornillo
NOTE: NE serrez PAS trop la vis

RP23336
O-Ring
Anillo "O"
Joint Torique

RP50880▲†
Trim Sleeve
Manga de Franja
Manchon de Finition

RP32102
Rotational Limit Stop
Tope para Limitar
Butée Rotative

RP32103▲
Handle Assembly
Ensamble de la Manija
Poignée

RP28595▲
Temperature Knob and Cover
Perilla de la Temperatura y Cubierta
Poignée de Réglage de Température

RP196▲
Trim Screws
Atornillos de Franja
Vis de Finition

RP12630▲
For Longer Screws
Para Tornillos Más Grandes
Pour Vis Plus Longues

*** RP46463**
Cartridge Assembly
Cartucho
Cartouche

RP28795▲
Escutcheon
Roseta
Rosace avec Orifice

RP28598
Decal (Red/Blue)
Etiqueta (Rojo/Azul)
Etiquette (Rouge/Bleu)

A74▲†

RP26852
Spindle/Husillo/Tige

RP5833▲ (Metal/Metálico/Métal)
Tub Spout/Non Diverter
Tubo de Salida para Bañera/
Sin Desviador
Bec/Sans Dérivation

RP17453
RP17454▲ (Metal/Metálico/Métal)
Tub Spout/Pull-Down Diverter
Tubo de Salida para Bañera/
Desviador de Halar
Bec/Avec Dérivation sur Embout

† Designates the accent color on split finish models
† Designa el color para acentuar los modelos con acabados divididos
† Désigne la couleur contrastante sur les modèles à deux finis

Classic Roman Tub Trim with Hand Shower

Robinetterie de baignoire romaine Classic avec douchette

Borde de bañera romana Classic con ducha de mano

Model/Modelo/Modèle T4705 Series/Series/Seria

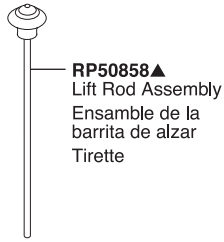

RP50858▲
Lift Rod Assembly
Ensamble de la
barrita de alzar
Tirette

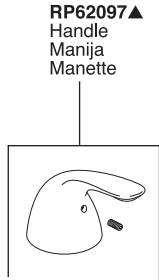

RP62097▲
Handle
Manija
Manette

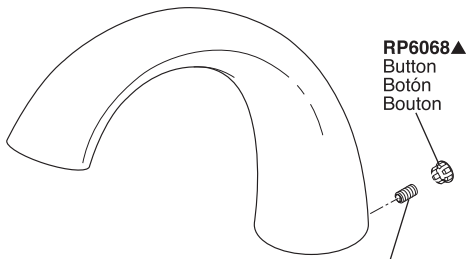

RP6068▲
Button
Botón
Bouton

RP152
Set Screw
Tornillo de
Presión
Vis de Calage

RP62094▲
Handle Base
w/Gasket
Base de la Manija
con Empaque
Embase de manette
avec Joint

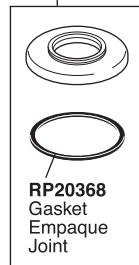

RP20368
Gasket
Empaque
Joint



RP46683▲
Hand Piece
Pieza de Mano
Douche à main

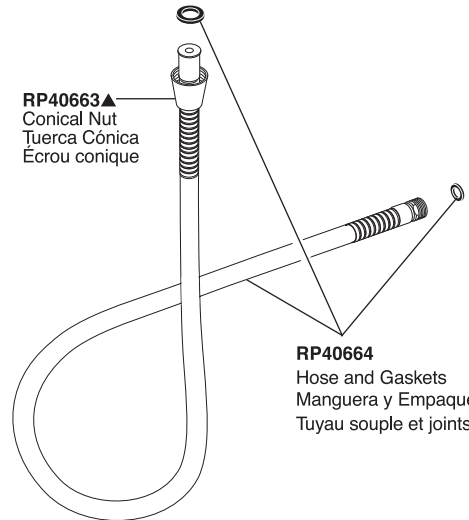

RP40663▲
Conical Nut
Tuerca Cónica
Écrou conique

RP40664
Hose and Gaskets
Manguera y Empaques
Tuyau souple et joints

RP41505▲
Hand Piece Base
Base para la Pieza de mano
Base de la douche à main

Classic Collection Roman Tub Trim Garniture de Bain Romain Collection Classic

Adorno para Bañera Romana de la Colección Classic

Classic Roman Tub

Model/Modelo/Modèle T5722 Series/Series/Seria

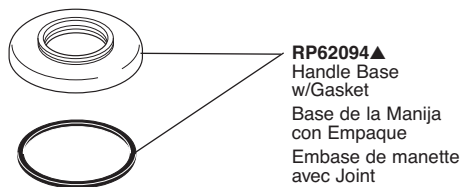
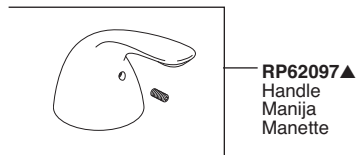
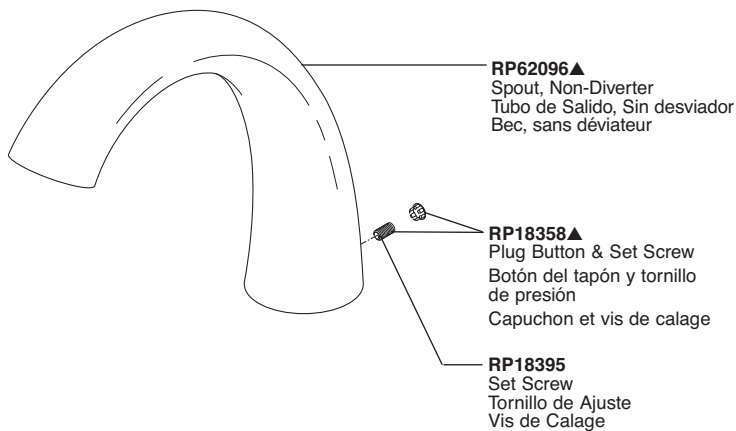

MultiChoice® Universal Tub/Shower Rough-In Body

Corps Universel Brut MultiChoice® pour Bain/Douche

tubería Interna Universal MultiChoice® para Bañera/Ducha

Tub/Shower Rough-In

Model/Modelo/Modèle R10000 Series/Series/Seria

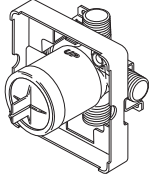

R10000-UN

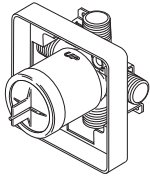

R10000-UNBX

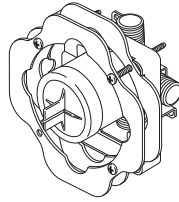

R10000-UNBXT

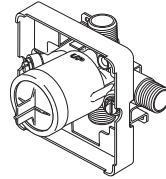

R10000-UNWS

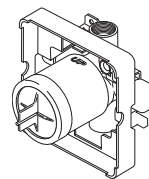

R10000-IP

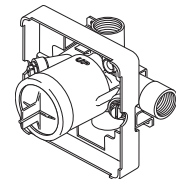

R10000-IPWS

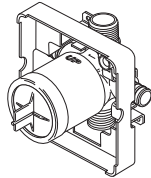

R10000-PX

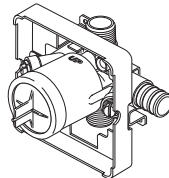

R10000-PXWS

Replacement Parts Piezas de Repuesto Pièces de rechange

RP46075
Plasterguard
Protector de yeso
Protecteur

RP46076
Cover
Cubierta
Couvercle

RP22734
Bonnet
Capuchón
Chapeau

RP46078
Test Cap
Tapa de Prueba
Capuchon d'essai

RP46077
Screen
Filtro de malla
Tamis

RP50366
Stop
Tope
Butée

RP46079*
Reusable Test Plug
(Sold as RP Only)
Tapón de Prueba Reutilizable
(Sólo se vende como Pieza de Repuesto)
Bouchon d'essai réutilisable
(pièce de rechange seulement)

RP47202
Thin Wall Mounting Kit
Soporte de montaje fino de la pared
Support mince de mur

RP63988
Deepwall Copper
Tubes (4)

*Used to plug one inlet side (Hot or Cold) to prevent cross flow when checking for leaks before the cartridge is installed. Insert into the inlet, place test cap and use the bonnet to secure in place.

*Tapaban una entrada lateral (caliente o frío) para prevenir flujo cruzado cuando la comprobación para saber si hay escapes antes del cartucho está instalada. El relleno en la entrada, casquillo de la prueba del lugar y utiliza el capo para asegurar en lugar.

*Branchaient une admission latérale (chaud ou froid) pour empêcher l'écoulement en travers quand la vérification les fuites avant la cartouche est installée. L'insertion dans l'admission, chapeau d'essai d'endroit et emploient le capot pour fixer en place.

Classic Tub/Shower Trim

Garniture pour Bain/Douche Classic

Adorno Classic para Bañera/Ducha

Classic Tub/Shower

Models/Modelos/Modèles T13090, T13091, T13290, T13291, T13490 & T13491 Series/Series/Seria



RP38357
Showerhead
Cabeza de Rogadora
Pomme de Douche



RP40594
Showerhead
Cabeza de Rogadora
Pomme de Douche



RP43381
Showerhead
Cabeza de Rogadora
Pomme de Douche

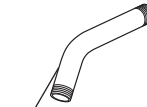

RP6023
Shower Arm
Brazo de la Rogadora
Tuyau de Pomme de Douche



RP6025
Shower Flange
Pestaña de la Rogadora
Collerette

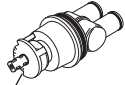

RP47312
Ceramic Valve Cartridge
Válvula de Cartucho
de Cerámica
Cartouche Céramique

RP196
Trim Screws/Atornillos de Franja/
Vis de Finition

RP12630
For Longer Screws
Para Tornillos Más Grandes
Pour Vis Plus Longues

061050A
Escutcheon
Roseta
Rosace avec Orifice

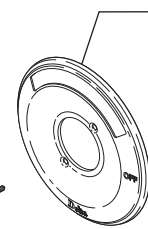

***RP46074**
13/14 Series Valve Cartridge
13/14 Series Válvula
de Cartucho
13/14 Série Cartouche

RP23336
O-Ring
Anillo "O"
Joint Torique

RP50879
Trim Sleeve
Manga de Franja
Manchon de Finition

RP4993
Seats & Springs
Asientos y Resortes
Sièges et Ressorts

RP14414
O-Rings
Anillos "O"
Joints Toriques

H78
Handle Kit
Juego de herrajes de la Manija
Manette en kit

RP36198
Screw
Tornillo
Vis

RP29569
Spacer
Separadores
Pièce
D'espacement

RP33403▲
Tub Spout/Pull-Up Diverter
Tubo de Salida para Bañera/
Botón Desviador de Alzar
Bec/avec dérivation à tirette

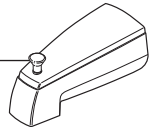

RP5834
(Non Metal/Sin Metálico/Sans Métal)
Tub Spout/Pull-Up Diverter
Tubo de Salida para Bañera/
Botón Desviador de Alzar
Bec/avec dérivation à tirette

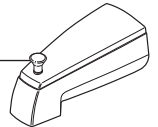

RP19895
(Metal / Metálico / Métal)
Tub Spout/Pull-Up Diverter
Tubo de Salida para Bañera/
Botón Desviador de Alzar
Bec/avec dérivation à tirette

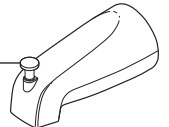

RP5833
Tub Spout/Non Diverter
Tubo de Salida para Bañera/
Sin Desviador
Bec/Sans Dérivation



H79
Handle Kit
Juego de herrajes
de la Manija
Manette en kit

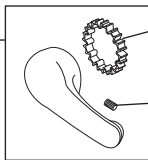

RP29569
Spacer
Separadores
Pièce D'espacement

RP152
Set Screw
Tornillo de Ajuste
Vis de Calage

Jetted Shower™ Jet Module Module à Jet Jetted Shower™

Módulo de Chorro Jetted Shower™

Models/Modelos/Modèles R1817, T1817, T1837, R1827, T18017 & T18037 Series/Series/Seria

R1817, T1817 & T1837

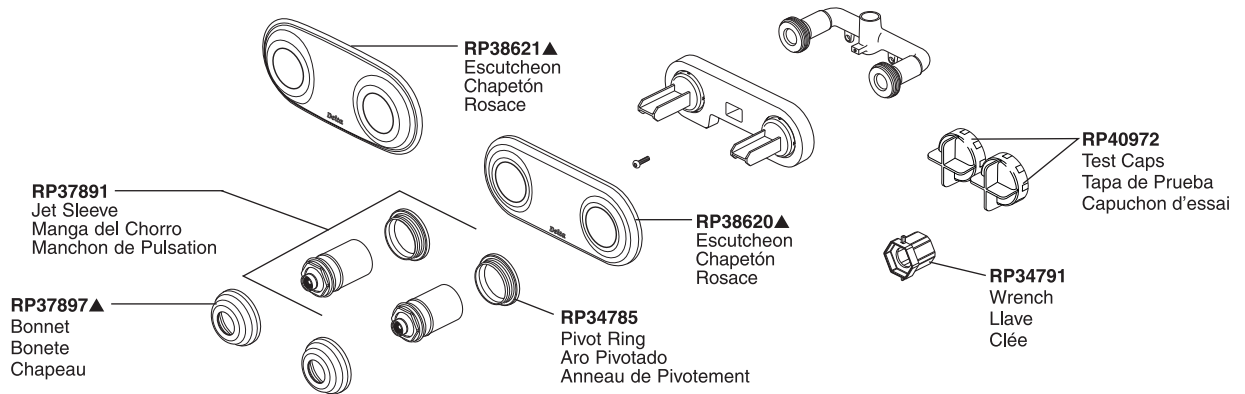

R1827, T18017 & T18037

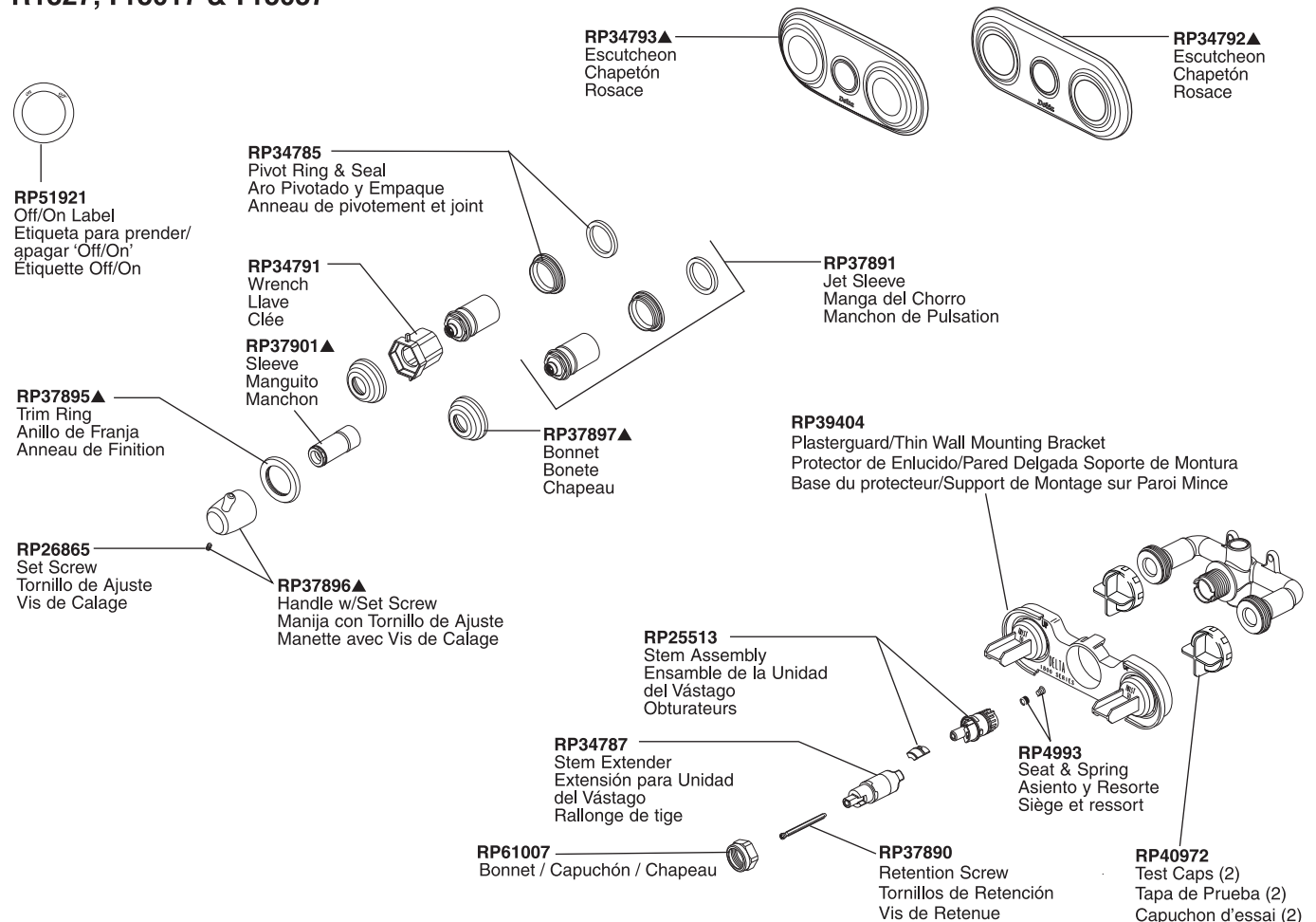

Deck Mount Roman Tub Rough-In Kit Corps de Robinet Pour Rebord de Bain Romain

Juego de tubería interna para instalación en tina tipo Romana con soporte de plataforma

Roman Tub Rough-In

Model/Modelo/Modèle R2707 Series/Series/Seria

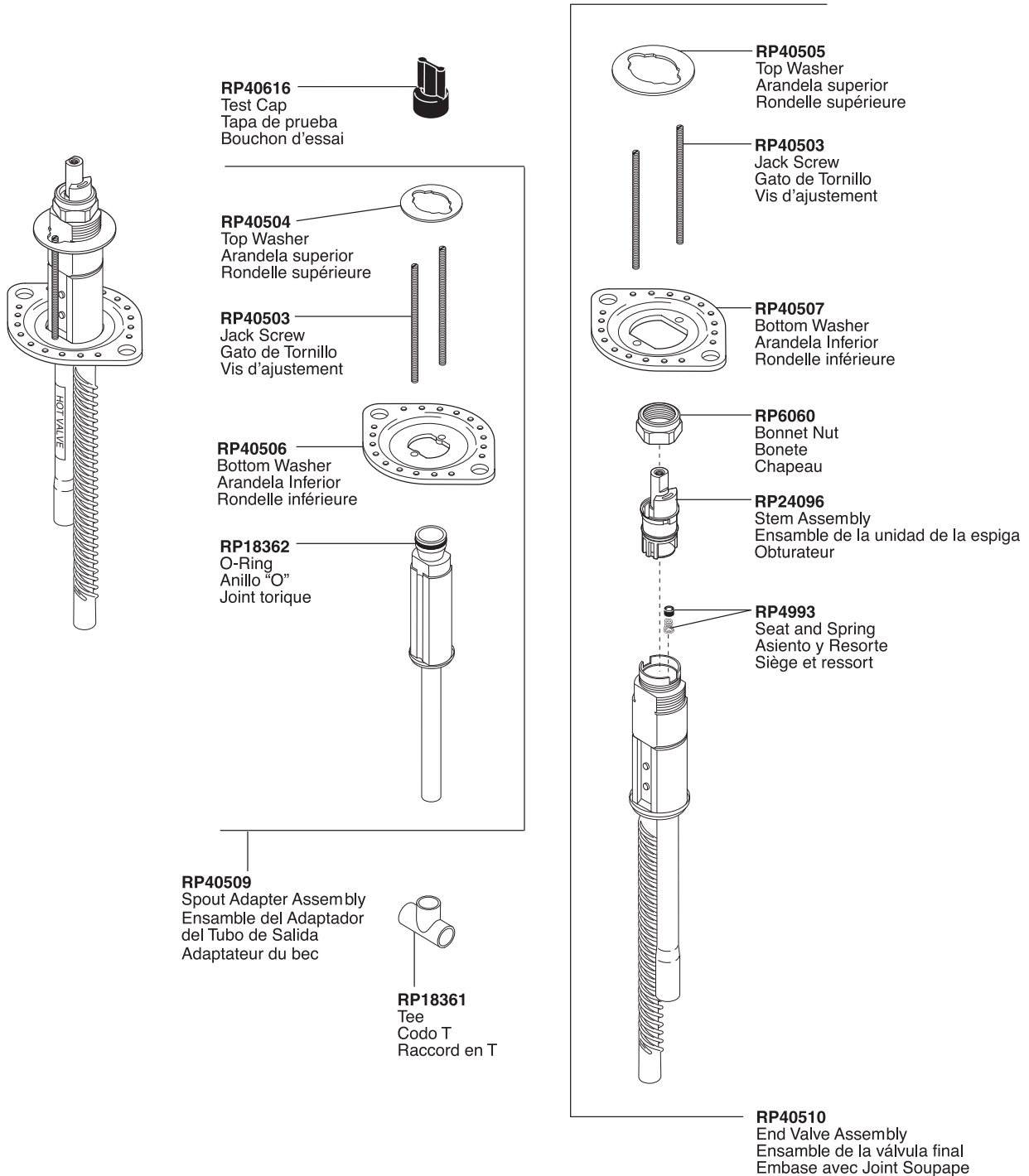

Intended for surfaces up to 2 1/2" thick excluding plywood underlayment.
Para superficies hasta 2 1/2" de grosor excluyendo contrapiso de madera contrachapada.
Plages d'au plus 2 1/2 po, épaisseur du panneau de sous-finition en contreplaqué exclue.

▲ Specify finish / Especificque el Acabado / Précisez le fini

Classic Roman Tub Trim Garniture de Bain Romain Classique

Adorno Clásica para Bañera Romana

Classic Roman Tub

Model/Modelo/Modèle T2705 Series/Series/Seria

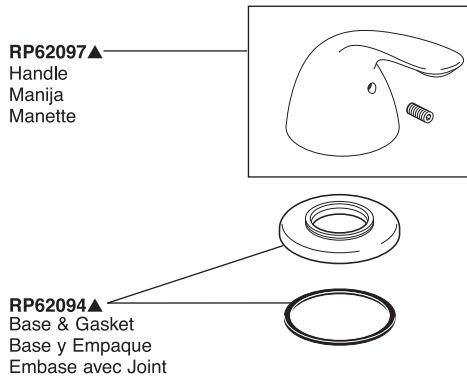
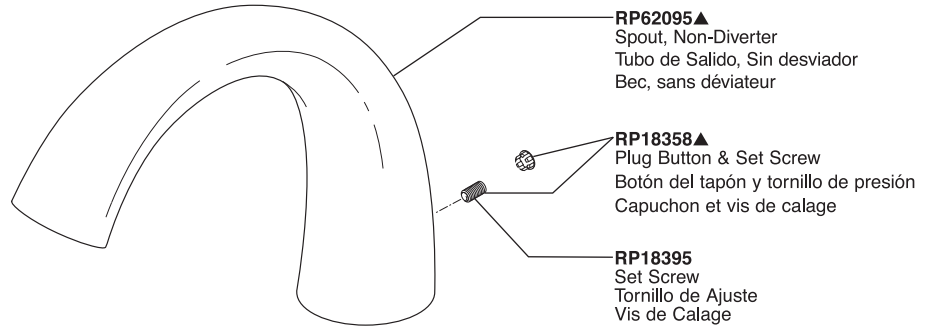

Roman Tub Hand Held Shower and Diverter

Douche à Main et Dérivation Pour Bain Romain

Ducha de Mano para Bañeras Romanas y Desviador

Model/Modelo/Modèle RP14979 Series/Series/Seria

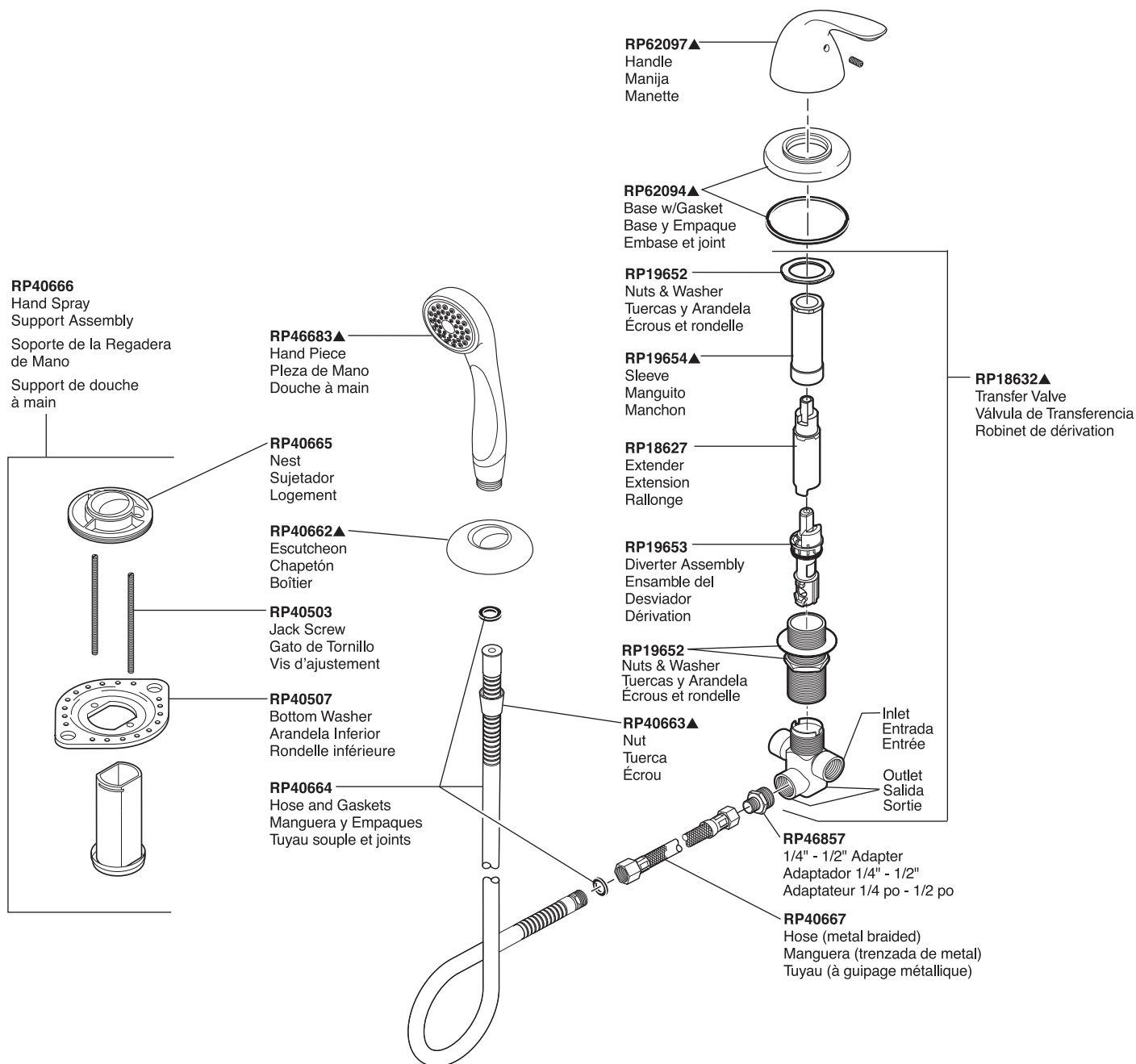

Body Spray Jet de Douche

Rociador para el Cuerpo

Models/Modelos/Modèles 50000 Series/Series/Seria

Body Spray

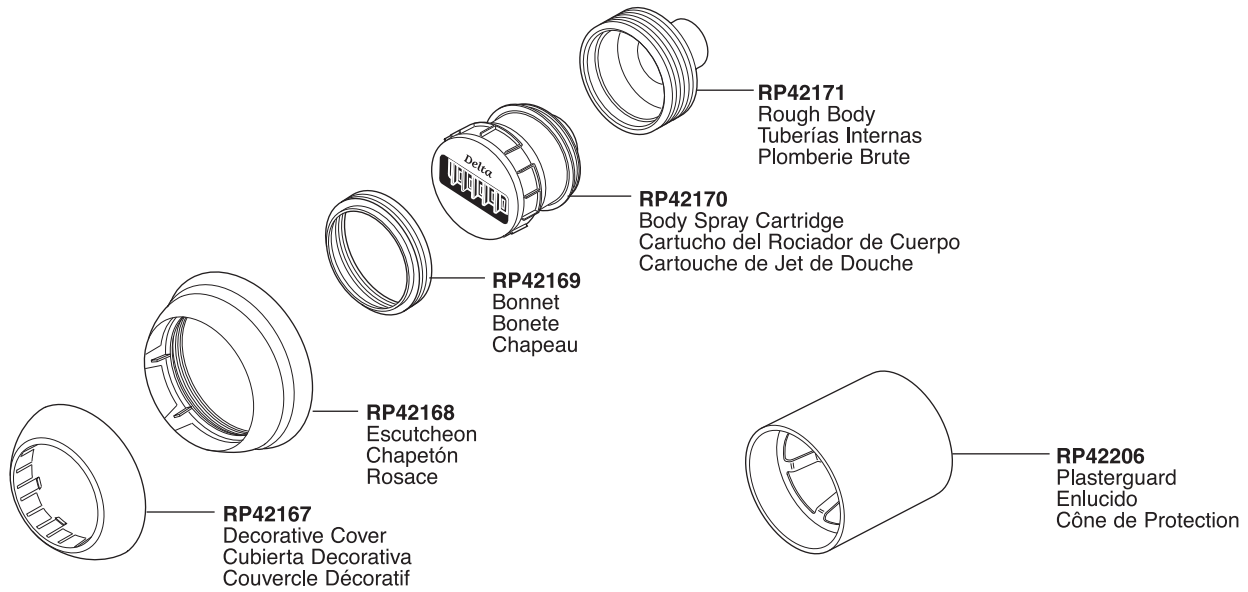

Wall Mount Hand Shower Douchette Murale

Ducha de Mano con Montaje de Pared

Models/Modelos/Modèles 54510, 54513, 56510 & 56513 Series/Series/Seria

54510

RP46680▲

Traditional Single Function Hand Piece
Ducha Tradicional De la Mano De Sola Función
Embout à main traditionnel fonction unique

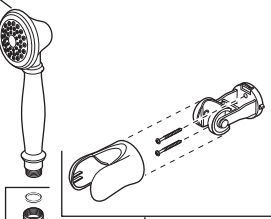

RP48771▲
Wall Mount Bracket
Abrazadera de Montura
para la Pared
Support mural

RP48782▲

69" Plastic Hose w/Gaskets
Manguera Plástica del 69" con las Empaques
Tuyau en plastique de 1,75 m (69 po) avec joints

54513

RP48770▲

Traditional Three Function Hand Piece
Ducha Tradicional De la Mano De Tres Funciones
Embout à main traditionnel triple fonction

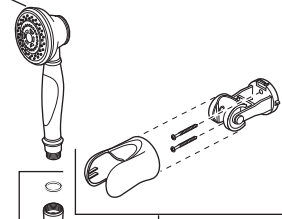

RP48771▲
Wall Mount Bracket
Abrazadera de Montura
para la Pared
Support mural

RP48782▲

69" Plastic Hose w/Gaskets
Manguera Plástica del 69" con las Empaques
Tuyau en plastique de 1,75 m (69 po) avec joints

56510

RP46683▲

Contemporary Single Function Hand Piece
Ducha Contemporáneo De la Mano De Sola Función
Embout à main contemporain fonction unique

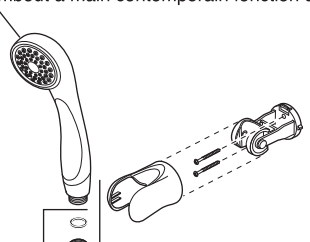

RP48771▲
Wall Mount Bracket
Abrazadera de Montura
para la Pared
Support mural

RP48782▲

69" Plastic Hose w/Gaskets
Manguera Plástica del 69" con las Empaque
Tuyau en plastique de 1,75 m (69 po) avec joints

56513

RP48769▲

Contemporary Three Function Hand Piece
Ducha Contemporáneo De la Mano De Tres Funciones
Embout à main contemporain triple fonction

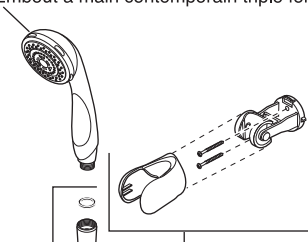

RP48771▲
Wall Mount Bracket
Abrazadera de Montura
para la Pared
Support mural

RP48782▲

69" Plastic Hose w/Gaskets
Manguera Plástica del 69" con las Empaques
Tuyau en plastique de 1,75 m (69 po) avec joints

Slide Bar and Shower Mount Hand Showers

Barres Coulissante et Douchettes Murale

Montajes de Pared y Duchas de Mano con Montaje de Ducha

Models/Modelos/Modèles 54713, 55710 & 56713 Series/Series/Seria

54713 RP48770▲

Traditional Three Function Hand Piece
Ducha Tradicional De la Mano De Tres Funciones
Embout à main traditionnel triple fonction

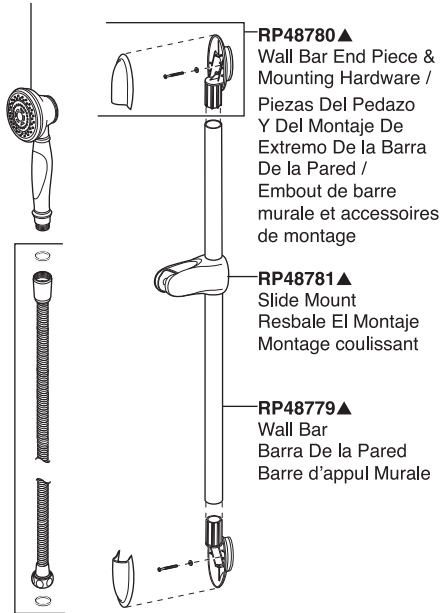

RP48782▲
69" Plastic Hose w/Gaskets
Manguera Plástica del 69" con las Empaques
Tuyau en plastique de 1,75 m (69 po) avec joints

55710 RP46680▲

Traditional Single Function Hand Piece
Ducha Tradicional De la Mano De Sola Función
Embout à main traditionnel fonction unique

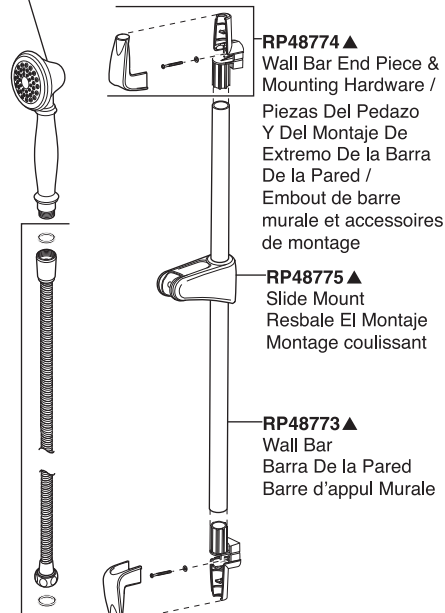

RP48782▲
69" Plastic Hose w/Gaskets
Manguera Plástica del 69" con las Empaques
Tuyau en plastique de 1,75 m (69 po) avec joints

56713 RP48769▲

Contemporary Three Function Hand Piece
Ducha Contemporáneo De la Mano De Tres Funciones
Embout à main contemporain triple fonction

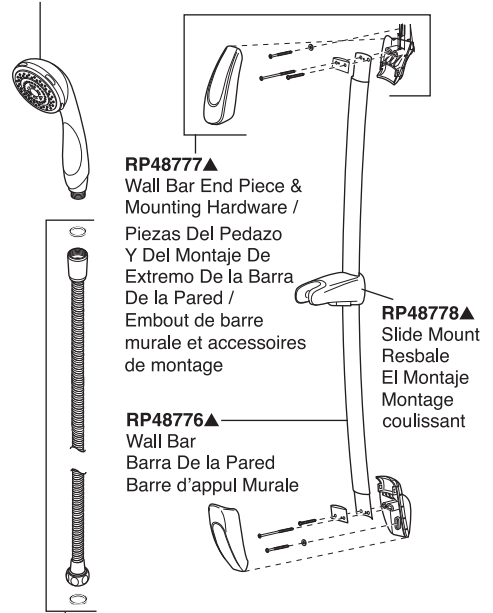

RP48782▲
69" Plastic Hose w/Gaskets
Manguera Plástica del 69" con las Empaques
Tuyau en plastique de 1,75 m (69 po) avec joints

Models/Modelos/Modèles 54613 & 56613 Series/Series/Seria

54613 RP48770▲

Traditional Three Function Hand Piece
Ducha Tradicional De la Mano De Tres Funciones
Embout à main traditionnel triple fonction

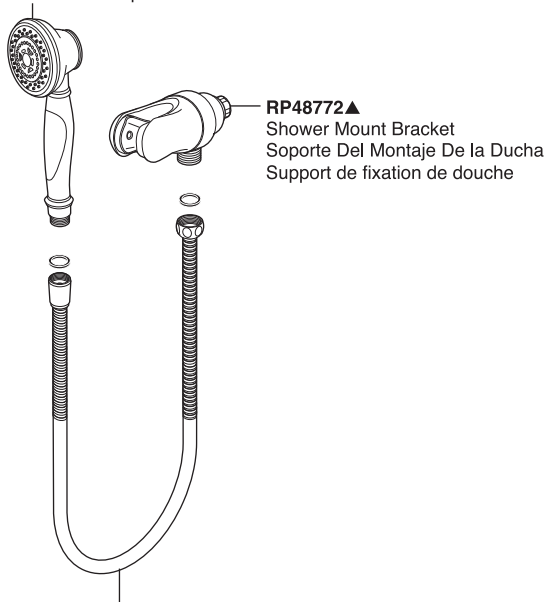

RP48782▲
69" Plastic Hose w/Gaskets
Manguera Plástica del 69" con las Empaques
Tuyau en plastique de 1,75 m (69 po) avec joints

56613 RP48769▲

Contemporary Three Function Hand Piece
Ducha Contemporáneo De la Mano De Tres Funciones
Embout à main contemporain triple fonction

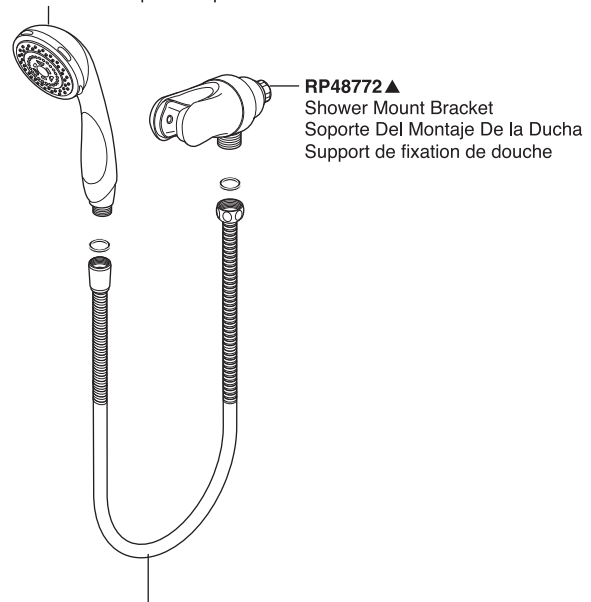

RP48782▲
69" Plastic Hose w/Gaskets
Manguera Plástica del 69" con las Empaques
Tuyau en plastique de 1,75 m (69 po) avec joints

Bath Installation Aids, Accessories & Parts

Aides, accessoires et pièces pour l'installation de salles de bains

Ayudas, accesorios y piezas para la instalación en baño

Model/Modelo/Modèle RP293 Series/Series/Seria
 (20 ga. Brass/Bronce de 20 calibres/Laiton calibre 20)

Model/Modelo/Modèle RP693 Series/Series/Seria
 (17 ga. Brass/Bronce de 17 calibres/Laiton calibre 17)

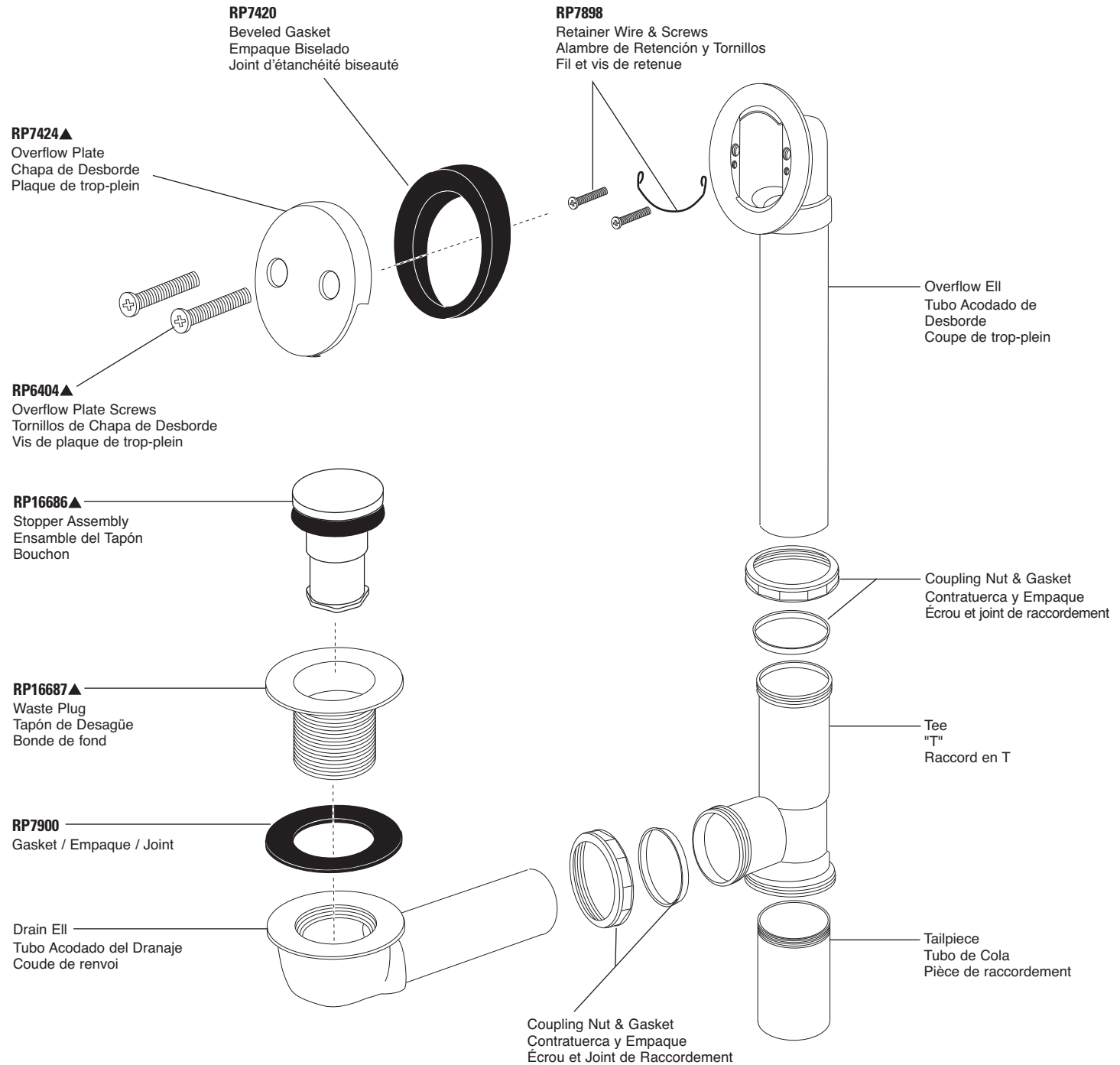

Bath Installation Aids, Accessories & Parts

Aides, accessoires et pièces pour l'installation de salles de bains

Ayudas, accesorios y piezas para la instalación en baño

Model/Modelo/Modèle RP393 Series/Series/Seria (Polypropylene/Poliproileno/Polypropylène)

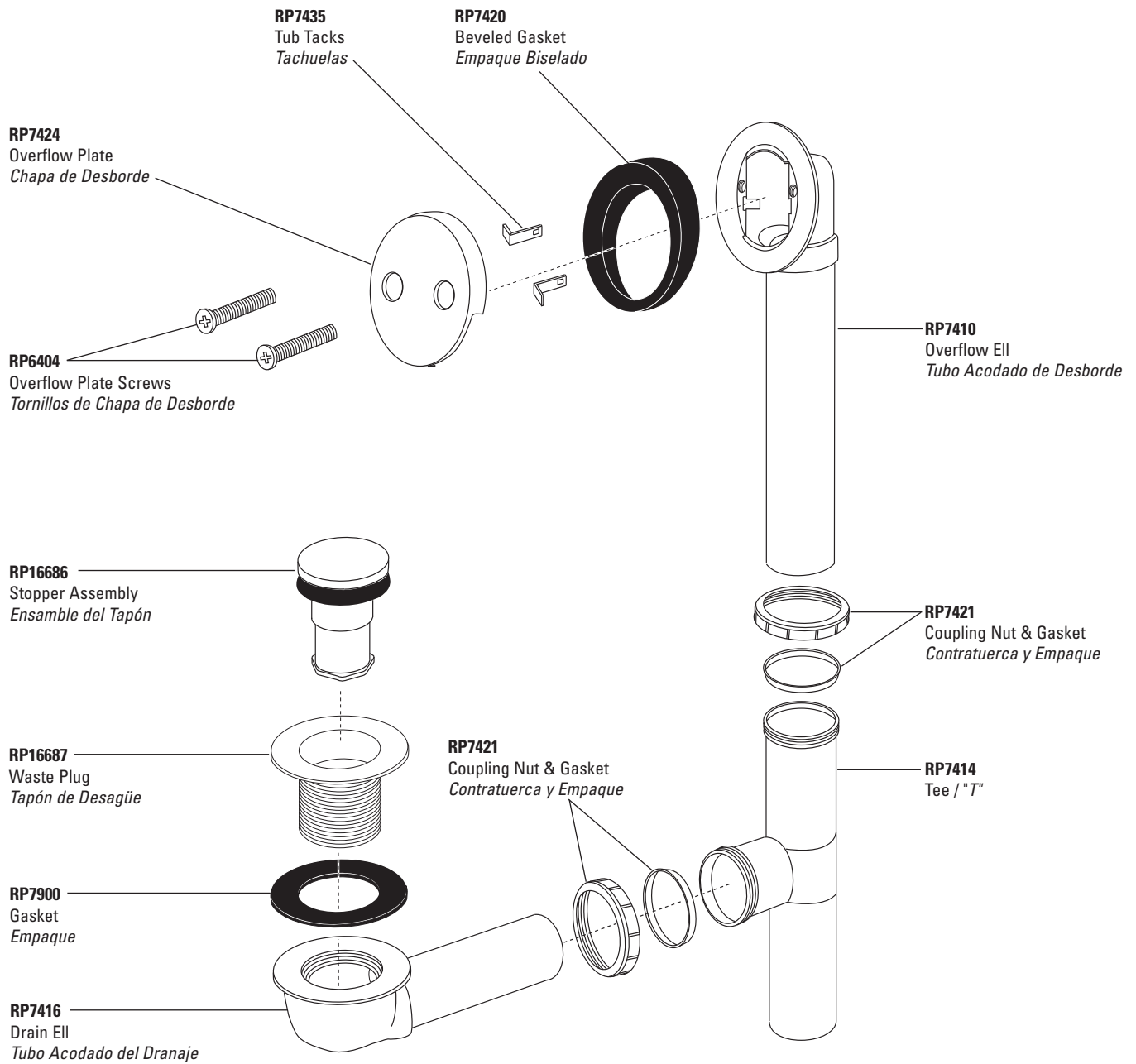

Bidet Valve

Soupape à Bidet

Válvulas para Bidés

Bidets

Model/Modelo/Modèle 33 Series/Series/Seria

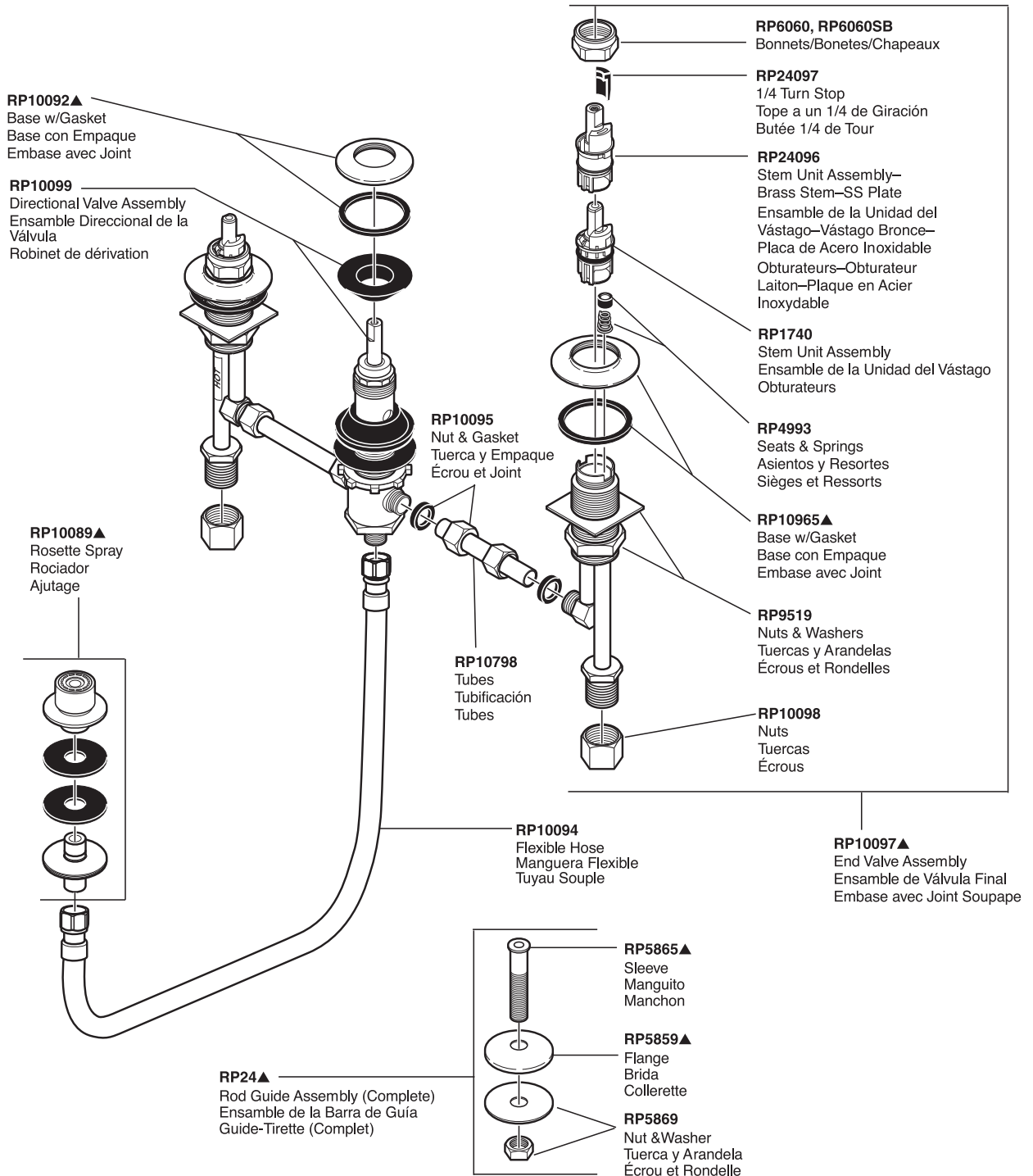

Refer to handles on page 94 for handle options./ Refiérase a mangos en la página 94 para opciones de mango./ Faites allusion aux poignées sur la page 94 pour les options de poignée.

Bidet Valve

Soupape à Bidet

Válvulas para Bidés

Model/Modelos/Modèle 44 Series/Series/Seria

Bidets

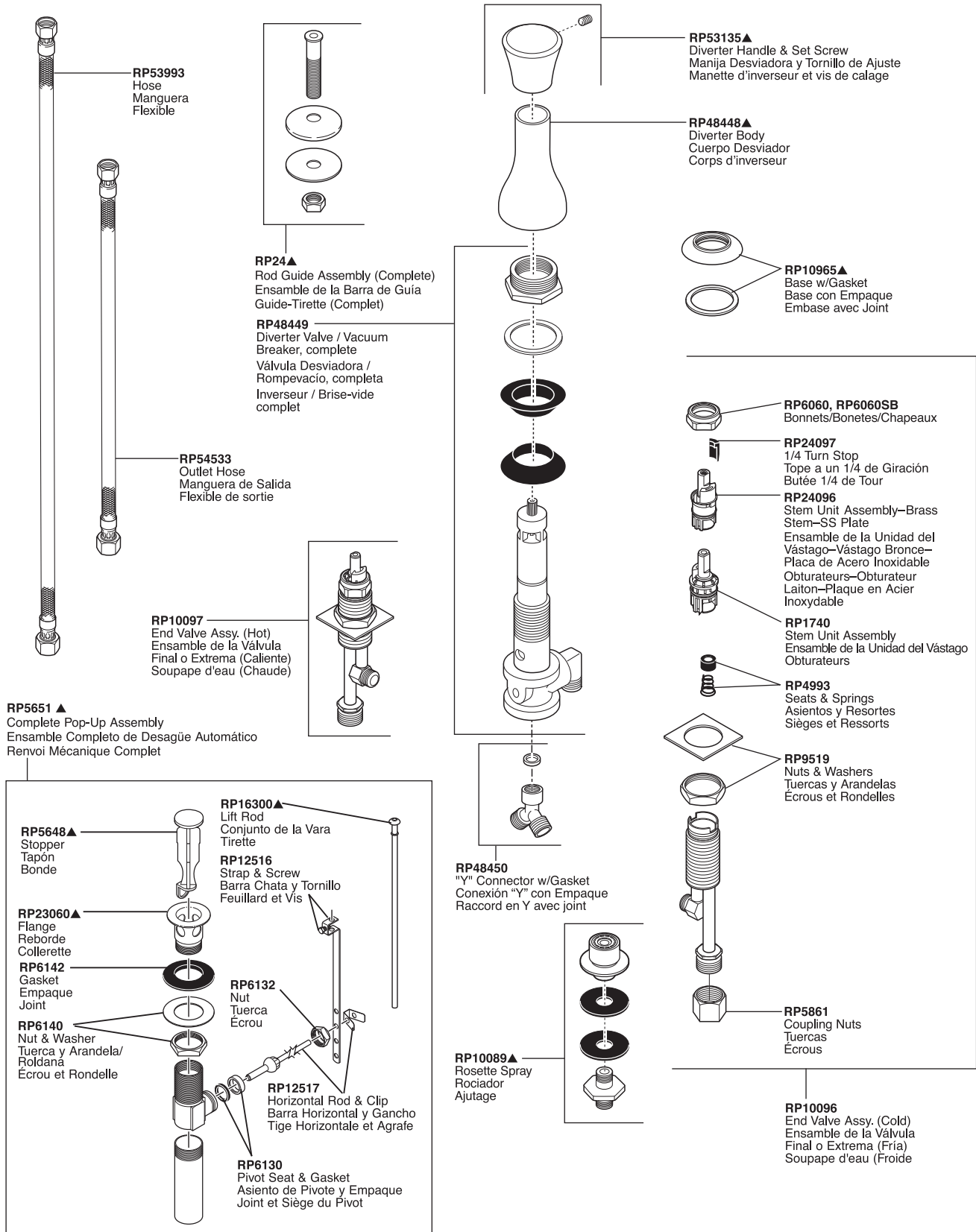

▲ Specify finish / Especificque el Acabado / Précisez le fini

Bidet Valve

Soupape à Bidet

Válvulas para Bidés

Model/Modelos/Modèle 33 & 44 Series/Series/Seria

Bidets

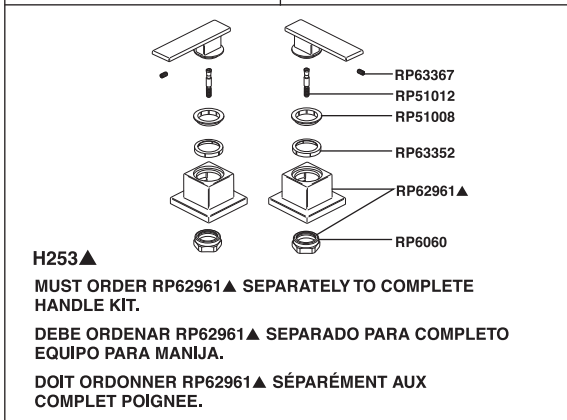
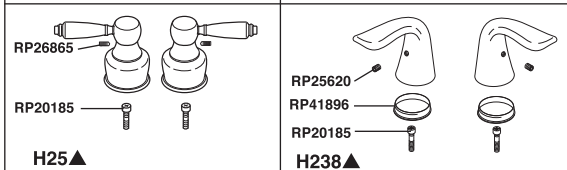
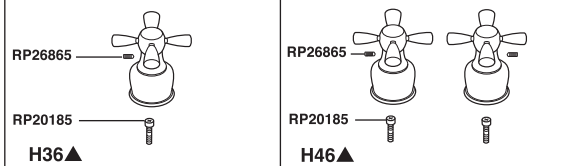
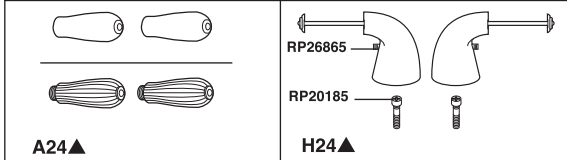
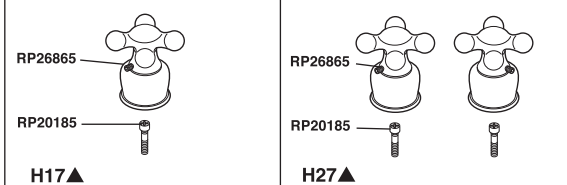
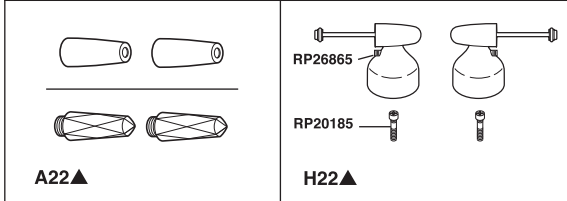
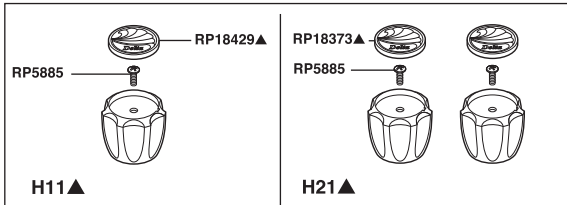

Contact your distributor for handle and accent options/finishes.
 Comuníquese con su distribuidor para obtener opciones en el tipo de manija y detalles (acentos)/acabados.
 Pour obtenir des renseignements sur les poignées, les garnitures et les finis livrables, veuillez communiquer avec votre distributeur.

